

**MercuryMedical**<sup>®</sup>  
Your Need ... Our Innovation<sup>®</sup>

# Medical Gas Fittings

The difference is quality.



# Table of Contents

---

<b>POLICY AND PROCEDURES</b> . . . . .	2	Adapters/Fittings/Neb Drive & Rescue Flow . . . . .	32
Adapters/Fittings/Chemetron (NCG) Style. . . . .	3-4	Adapters/Fittings/Valves. . . . .	33-34
Adapters/Fittings/Chemetron Style. . . . .	5	Adapters/Fittings/Wye Adapters . . . . .	35
Adapters/Fittings. . . . .	6	Hoses/Assemblies (Low Pressure). . . . .	36-38
Adapters/Fittings/Ohmeda (Ohio) Style. . . . .	7	Hose Ferrules/Tools. . . . .	39
Adapters/Fittings/Ohmeda Style. . . . .	8	Gauges/Magnehelic. . . . .	40
Adapters/Fittings/Oxequip Med*Star Style. . . . .	9	Gauges/Back Mount. . . . .	41
Adapters/Fittings/Oxequip O.E.S. (07) Style. . . . .	10	Gauges/Nitrogen/Miscellaneous. . . . .	42
Adapters/Fittings/Puritan-Bennett. . . . .	11	Gauges. . . . .	43-44
Adapters/Fittings/Schrader Style. . . . .	12-14	Gauges/Orifices. . . . .	45
Adapters/Fittings/D.I.S.S. . . . .	15	Gauges. . . . .	46
Adapters/Fittings/D.I.S.S. Female . . . . .	16	Gauges/Inspiratory Force. . . . .	47
Adapters/Fittings/D.I.S.S. Male . . . . .	17	Gauges/Patient Pressure. . . . .	48
Adapters/Fittings/D.I.S.S. Female X D.I.S.S. Male. . . . .	18	Gauges/Suction. . . . .	49-52
Adapters/Fittings. . . . .	19	Gauges/Test. . . . .	53
Adapters/Fittings/Check Valves. . . . .	20	Gauges/Bird Type. . . . .	54
Adapters/Fittings/Dynacon Style. . . . .	21	Regulators/Nitrogen. . . . .	55
Adapters/Fittings. . . . .	22	Electrical Supplies/PowerMATE®-IsoMATE®. . . . .	56
Adapters/Fittings/High Pressure. . . . .	23-26	Water Traps. . . . .	57
Adapters/Fittings. . . . .	27-29	Miscellaneous. . . . .	58-59
Adapters/Fittings/Miscellaneous Elbows, Tees, Wyes. . . . .	30	Technical Information. . . . .	60-63
Adapters/Fittings/Miscellaneous. . . . .	31	Public Health Notification. . . . .	64

# Policy and Procedures

## Mercury's Catalog...

offers a number of buying opportunities to help you economize for your hospital. We can save you money, and also offer prompt delivery. Please add Mercury Medical® to your bid list.

## Minimum Orders

There is a minimum order requirement of \$25.00. Authorized distributors must have a minimum order of \$750.00. Any orders which are under the minimum amount will be subject to a service charge.

## Prices and Availability

Mercury Medical is not responsible for any inadvertent errors in this catalog. Prices are not included in this catalog because we receive various price changes throughout the year. We will confirm our current prices with you when you place your order. Customer Service will be pleased to send you price information prior to you placing your order. Unless back-ordered, we will make every attempt to ship your order to you within one working day.

## Terms

Payment terms are Net 30 days. Charges of 1.5% apply to balances exceeding these terms. Credit cards accepted. No C.O.D.

## Shipping

All orders are shipped through our distribution via the "best method" as determined by Mercury Medical. United Parcel Service or Federal Express Ground where applicable is used unless otherwise specified.

## Claims

All claims for damaged or lost merchandise must be received within fifteen (15) days from receipt of order.

## Drop Shipments

Available from manufacturer in select situations with applicable fees.

## 30-Day Returned Goods Policy

All items returned to Mercury Medical must be accompanied by a return authorization number. Please call **(800) 835-MMED** to expedite returns. The request for return authorization must include the following:

- 1) Customer name, address, phone number and key contact person.
- 2) Catalog number and quantity.
- 3) Purchase order number and /or invoice number and date.
- 4) Reason for return.

There will be a charge of 25% of invoice price for restocking inventory that is in saleable condition.

## Special Notice on Returns

Deterioration of rubber, an organic material, is hastened by various factors. Therefore, rubber goods will not be accepted for return. Other non-returnable items include items not in original package, products with original packaging marked or defaced in any manner, and sterile products. Products which have been engraved with facility or user name are not returnable. All returns are subject to Mercury's approval.

## Warranty Information

Mercury Medical warrants that its workmanship will be free from defects for a minimum period of thirty days, unless otherwise stated.

Send repairs to:

MERCURY MEDICAL®  
Biomedical Clinical Services Div.  
11300 - 49th Street North  
Clearwater, FL 33762-4807

Include a purchase order, along with a description of work desired and authorized. Estimates are available for a small fee.

## Important Notice

MERCURY MEDICAL® handles many different product lines and receives pricing changes at various times during the year. For this reason, we have refrained from printing the prices in this catalog. Pricing information is available by calling: **(800) 835-MMED**.

Manufacturer names listed are the respective holders of their respective names and/or trademarks, and are not to be taken as an endorsement or affiliation with Mercury Medical.

# Adapters/Fittings/Chemetron (NCG) Style



- #69-20100 Chemetron oxygen adapter x 1/4" hose barb
- #69-20101 Chemetron nitrous oxide adapter x 1/4" hose barb
- #69-20102 Chemetron medical air adapter x 1/4" hose barb
- #69-20103 Chemetron vacuum adapter x 1/4" hose barb
- #69-20364 Chemetron vacuum adapter x 5/16" hose barb
- #69-20363 Chemetron WAGD adapter x 1/4" hose barb
- #69-21510 Chemetron WAGD adapter x 5/16" hose barb
- #69-20366 Chemetron carbon dioxide adapter x 1/4" hose barb (CO<sub>2</sub>>7%)
- #69-20367 Chemetron oxygen/carbon dioxide adapter x 1/4" hose barb (95% O<sub>2</sub>/5% CO<sub>2</sub>) (CO<sub>2</sub><7%)



- #69-20104 Chemetron oxygen adapter x 1/8 - 27 male
- #69-20105 Chemetron nitrous oxide adapter x 1/8 - 27 male
- #69-20106 Chemetron medical air adapter x 1/8 - 27 male
- #69-20107 Chemetron vacuum adapter x 1/8 - 27 male
- #69-20368 Chemetron WAGD adapter x 1/8 - 27 male
- #69-21253 Chemetron carbon dioxide adapter x 1/8 - 27 male
- #69-21272 Chemetron oxygen/carbon dioxide adapter x 1/8 - 27 male (95% O<sub>2</sub>/5% CO<sub>2</sub>)



- #69-21290 Chemetron WAGD adapter x D.I.S.S. WAGD female
- #69-20108 Chemetron oxygen adapter x D.I.S.S. oxygen female
- #69-20109 Chemetron nitrous oxide adapter x D.I.S.S. nitrous oxide female
- #69-20110 Chemetron medical air adapter x D.I.S.S. medical air female
- #69-20111 Chemetron vacuum adapter x D.I.S.S. vacuum female
- #69-21291 Chemetron carbon dioxide adapter x D.I.S.S. carbon dioxide female
- #69-21292 Chemetron oxygen/carbon dioxide adapter x D.I.S.S. female



- #69-21288 Chemetron carbon dioxide adapter x D.I.S.S. carbon dioxide male
- #69-21289 Chemetron oxygen/carbon dioxide adapter x D.I.S.S. male (95% O<sub>2</sub>/5% CO<sub>2</sub>)
- #69-20112 Chemetron oxygen adapter x D.I.S.S. oxygen male
- #69-20113 Chemetron nitrous oxide adapter x D.I.S.S. nitrous oxide male
- #69-20114 Chemetron medical air adapter x D.I.S.S. medical air male
- #69-20115 Chemetron vacuum adapter x D.I.S.S. vacuum male
- #69-21287 Chemetron WAGD adapter x D.I.S.S. WAGD male



- #69-21484 Chemetron vacuum adapter - Chemetron inlet to double vacuum D.I.S.S. female outlets, center mounted
- #69-20263 Chemetron oxygen adapter - Chemetron inlet to double oxygen D.I.S.S. female outlets, center mounted
- #69-20384 Chemetron medical air adapter - Chemetron inlet to double medical air D.I.S.S. female outlets, center mounted



- #69-21485 Chemetron medical air adapter - Chemetron inlet to double medical air D.I.S.S. female outlets, offset left
- #69-20264 Chemetron oxygen adapter - Chemetron inlet to double oxygen D.I.S.S. female outlets, offset left
- #69-21486 Chemetron vacuum adapter - Chemetron inlet to double vacuum D.I.S.S. female outlets, offset left



- #69-20265 Chemetron oxygen adapter - Chemetron inlet to double oxygen D.I.S.S. female outlets, offset right
- #69-21487 Chemetron medical air adapter - Chemetron inlet to double medical air D.I.S.S. female outlets, offset right
- #69-21488 Chemetron vacuum- Chemetron inlet to double vacuum D.I.S.S. female outlets, offset right

## Adapters/Fittings/Chemetron (NCG) Style

---



- #69-20116 Chemetron oxygen coupler x 1/4" hose barb
  - #69-20117 Chemetron nitrous oxide coupler x 1/4" hose barb
  - #69-20118 Chemetron medical air coupler x 1/4" hose barb
  - #69-20119 Chemetron vacuum coupler x 1/4" hose barb
  - #69-20369 Chemetron WAGD coupler x 1/4" hose barb
  - #69-20371 Chemetron carbon dioxide coupler x 1/4" hose barb (CO<sub>2</sub> > 7%)
  - #69-20372 Chemetron carbon dioxide coupler x 1/4" hose barb (CO<sub>2</sub> < 7%)
  - #69-21511 Chemetron vacuum coupler x 5/16" hose barb
  - #69-21510 Chemetron WAGD coupler x 5/16" hose barb
- 



- #69-20386 Chemetron carbon dioxide coupler x 1/8 - 27 male (CO<sub>2</sub> > 7%)
  - #69-20387 Chemetron carbon dioxide coupler x 1/4 - 18 male (CO<sub>2</sub> > 7%)
  - #69-20121 Chemetron oxygen coupler x 1/8 - 27 male
  - #69-20124 Chemetron oxygen coupler x 1/4 - 18 male
  - #69-20122 Chemetron vacuum coupler x 1/8 - 27 male
  - #69-20125 Chemetron vacuum coupler x 1/4 - 18 male
  - #69-20123 Chemetron medical air coupler x 1/8 - 27 male
  - #69-20127 Chemetron medical air coupler x 1/4 - 18 male
  - #69-20126 Chemetron nitrous oxide coupler x 1/4 - 18 male
  - #69-20374 Chemetron nitrous oxide coupler x 1/8 - 27 male
  - #69-20373 Chemetron WAGD coupler x 1/4 - 18 male
  - #69-20375 Chemetron WAGD coupler x 1/8 - 27 male
- 



- #69-20120 Chemetron oxygen coupler x D.I.S.S. oxygen male
  - #69-20376 Chemetron nitrous oxide coupler x D.I.S.S. nitrous oxide male
  - #69-20377 Chemetron medical air coupler x D.I.S.S. medical air male
  - #69-20378 Chemetron vacuum coupler x D.I.S.S. vacuum male
  - #69-20379 Chemetron WAGD coupler x D.I.S.S. WAGD male
  - #69-20381 Chemetron carbon dioxide coupler x D.I.S.S. carbon dioxide male
- 



- #69-21293 Chemetron oxygen coupler x 1/8 - 27 female
- #69-21294 Chemetron nitrous oxide coupler x 1/8 - 27 female
- #69-21295 Chemetron medical air coupler x 1/8 - 27 female
- #69-21296 Chemetron vacuum coupler x 1/8 - 27 female
- #69-21531 Chemetron WAGD coupler x 1/8 - 27 female

# Adapters/Fittings/Chemetron Style

---



- #69-21273 Chemetron oxygen adapter x 1/8 - 27 female
  - #69-21274 Chemetron nitrous oxide adapter x 1/8 - 27 female
  - #69-21275 Chemetron medical air adapter x 1/8 - 27 female
  - #69-21276 Chemetron vacuum adapter x 1/8 - 27 female
  - #69-21277 Chemetron WAGD adapter x 1/8 - 27 female
  - #69-21278 Chemetron carbon dioxide adapter x 1/8 - 27 female
  - #69-21279 Chemetron 95% O<sub>2</sub>/5% CO<sub>2</sub> adapter x 1/8 - 27 female
- 



- #69-21280 Chemetron oxygen adapter x 1/4 - 18 male
  - #69-21281 Chemetron nitrous oxide adapter x 1/4 - 18 male
  - #69-21282 Chemetron medical air adapter x 1/4 - 18 male
  - #69-21283 Chemetron vacuum adapter x 1/4 - 18 male
  - #69-21284 Chemetron WAGD adapter x 1/4 - 18 male
  - #69-21285 Chemetron carbon dioxide adapter x 1/4 - 18 male
  - #69-21286 Chemetron 95% O<sub>2</sub>/5% CO<sub>2</sub> adapter x 1/4 - 18 male
- 



- #69-21600 Chemetron oxygen coupler x D.I.S.S. oxygen female hand nut (not shown)
  - #69-21809 Chemetron oxygen coupler x D.I.S.S. oxygen female hex nut
  - #69-21850 Chemetron nitrous oxide coupler x D.I.S.S. nitrous oxide female hex nut
  - #69-21848 Chemetron medical air coupler x D.I.S.S. medical air female hex nut
  - #69-21849 Chemetron vacuum coupler x D.I.S.S. vacuum female hex nut
  - #69-21854 Chemetron WAGD coupler x D.I.S.S. WAGD female hex nut
  - #69-21880 Chemetron carbon dioxide coupler x D.I.S.S. carbon dioxide female
- 



- #69-21600 Chemetron oxygen coupler x D.I.S.S. oxygen female hand nut
  - #69-21605 Chemetron nitrous oxide coupler x D.I.S.S. nitrous oxide female hand nut
  - #69-21606 Chemetron medical air coupler x D.I.S.S. medical air female hand nut
  - #69-21607 Chemetron vacuum coupler x D.I.S.S. vacuum female hand nut
  - #69-218191 Chemetron WAGD coupler x D.I.S.S. WAGD female hand nut
- 



- #69-21254 Chemetron oxygen duplex - wye style
- #69-21265 Chemetron vacuum duplex - wye style
- #69-21266 Chemetron medical air duplex - wye style
- #69-21271 Chemetron nitrous oxide duplex - wye style

# Adapters/Fittings

---



- #69-20189\* Chemetron oxygen adapter - center mounted
  - #69-20190\* Chemetron medical air adapter - center mounted
  - #69-20191\* Chemetron vacuum adapter - center mounted
  - #69-21842\* Chemetron nitrous oxide adapter - center mounted
- 



- #69-20192\* Chemetron oxygen adapter - offset left mounted
  - #69-20262\* Chemetron vacuum adapter - offset left mounted
  - #69-20382\* Chemetron medical air adapter - offset left mounted
- 



- #69-20402\* Chemetron oxygen adapter - offset right mounted
- #69-20403\* Chemetron vacuum adapter - offset right mounted
- #69-20383\* Chemetron medical air adapter - offset right mounted

\* Couplers spaced 4-1/2" on-center measurement

---



- #69-20266 Chemetron vacuum adapter, bottle holder type. Hose barb outlet with on/off switch.
- 



- #69-20267 Chemetron vacuum adapter, bottle holder type. Two hose barb outlets with on/off switch.
- 



- #69-20389 Ohmeda vacuum adapter, bottle holder type. Two hose barb outlets with on/off switch.
- 



- #69-20268 D.I.S.S. vacuum adapter, Chemetron bottle holder type. D.I.S.S. female inlet, hose barb outlet with on/off switch.
- 



- #69-20269 D.I.S.S. vacuum adapter, Chemetron bottle holder type. D.I.S.S. female inlet, two hose barb outlets with on/off switch.

# Adapters/Fittings/Ohmeda (Ohio) Style



- #69-20138 Ohmeda type oxygen adapter x 1/4" hose barb
- #69-20139 Ohmeda type nitrous oxide adapter x 1/4" hose barb
- #69-20140 Ohmeda type medical air adapter x 1/4" hose barb
- #69-20141 Ohmeda type vacuum adapter x 1/4" hose barb
- #69-21512 Ohmeda type vacuum adapter x 5/16" hose barb
- #69-20501 Ohmeda type WAGD adapter x 1/4" hose barb
- #69-21513 Ohmeda type WAGD adapter x 5/16" hose barb
- #69-20760 Ohmeda carbon dioxide adapter x 1/4" hose barb



- #69-21304 Ohmeda type vacuum adapter x D.I.S.S. vacuum female
- #69-20146 Ohmeda type oxygen adapter x D.I.S.S. oxygen female
- #69-20393 Ohmeda type medical air adapter x D.I.S.S. medical air female
- #69-21886 Ohmeda type nitrous oxide adapter x D.I.S.S. nitrous oxide female
- #69-21305 Ohmeda type WAGD adapter x D.I.S.S. WAGD female
- #69-21306 Ohmeda carbon dioxide adapter x D.I.S.S. carbon dioxide female



- #69-20390 Ohmeda type oxygen adapter x 1/4 - 18 male
- #69-20142 Ohmeda type oxygen adapter x 1/8 - 27 male
- #69-20391 Ohmeda type medical air adapter x 1/4 - 18 male
- #69-20144 Ohmeda type medical air adapter x 1/8 - 27 male
- #69-20392 Ohmeda type vacuum adapter x 1/4 - 18 male
- #69-20145 Ohmeda type vacuum adapter x 1/8 - 27 male
- #69-20500 Ohmeda type WAGD adapter x 1/8 - 27 male
- #69-20143 Ohmeda type nitrous oxide adapter x 1/8 - 27 male
- #69-20761 Ohmeda carbon dioxide adapter x 1/8 - 27 male
- #69-21300 Ohmeda type WAGD adapter x 1/4 - 18 male
- #69-21301 Ohmeda carbon dioxide adapter x 1/4 - 18 male



- #69-21302 Ohmeda type WAGD adapter x D.I.S.S. WAGD male
- #69-30072 Ohmeda type oxygen adapter x D.I.S.S. oxygen male (*pictured*)
- #69-30061 Ohmeda type vacuum adapter x D.I.S.S. vacuum male
- #69-20394 Ohmeda type nitrous oxide adapter x D.I.S.S. nitrous oxide male
- #69-30060 Ohmeda type medical air adapter x D.I.S.S. medical air male
- #69-21303 Ohmeda carbon dioxide adapter x D.I.S.S. carbon dioxide male



- #69-20270 Ohmeda type oxygen adapter x 1/8 - 27 female
- #69-20271 Ohmeda type nitrous oxide adapter x 1/8 - 27 female
- #69-20272 Ohmeda type medical air adapter x 1/8 - 27 female
- #69-20273 Ohmeda type vacuum adapter x 1/8 - 27 female
- #69-21297 Ohmeda type WAGD adapter x 1/8 - 27 female
- #69-21298 Ohmeda carbon dioxide adapter x 1/8 - 27 female



- #69-30054 Ohmeda type oxygen male x (2) Ohmeda oxygen female checks
- #69-30055 Ohmeda type vacuum male x (2) Ohmeda vacuum female checks
- #69-30056 Ohmeda type nitrous oxide male x (2) Ohmeda nitrous oxide checks
- #69-30057 Ohmeda type medical air male (2) Ohmeda medical air checks



# Adapters/Fittings/Ohmeda Style

---



- #69-21514 Ohmeda type vacuum coupler x 5/16" hose barb
  - #69-20989 Ohmeda type oxygen coupler x 1/4" hose barb
  - #69-20990 Ohmeda type nitrous oxide coupler x 1/4" hose barb
  - #69-20991 Ohmeda type medical air coupler x 1/4" hose barb
  - #69-20992 Ohmeda type vacuum coupler x 1/4" hose barb
  - #69-20762 Ohmeda carbon dioxide coupler x 1/4" hose barb
  - #69-21496 Ohmeda type WAGD coupler x 5/16" hose barb
  - #69-21499 Ohmeda type WAGD coupler x 1/4" hose barb
- 



- #69-20147 Ohmeda type oxygen coupler x 1/4 -18 male
  - #69-20148 Ohmeda type nitrous oxide coupler x 1/4 - 18 male
  - #69-20149 Ohmeda type medical air coupler x 1/4 - 18 male
  - #69-20150 Ohmeda type vacuum coupler x 1/4 - 18 male
  - #69-20395 Ohmeda WAGD coupler x 1/4 - 18 male
  - #69-21528 Ohmeda carbon dioxide coupler x 1/4 - male
- 



- #69-21524 Ohmeda WAGD coupler x 1/8 - 27 male
  - #69-21337 Ohmeda oxygen coupler x 1/8 - 27 male
  - #69-21338 Ohmeda nitrous oxide coupler x 1/8 - 27 male
  - #69-21339 Ohmeda medical air coupler x 1/8 - 27 male
  - #69-21340 Ohmeda vacuum coupler x 1/8 - 27 male
  - #69-21526 Ohmeda carbon dioxide coupler x 1/8 - 27 male
- 



- #69-21525 Ohmeda WAGD coupler x 1/8 - 27 female
  - #69-21342 Ohmeda oxygen coupler x 1/8 - 27 female
  - #69-21370 Ohmeda nitrous oxide coupler x 1/8 - 27 female
  - #69-21371 Ohmeda medical air coupler x 1/8 - 27 female
  - #69-21372 Ohmeda vacuum coupler x 1/8 - 27 female
  - #69-21527 Ohmeda carbon dioxide coupler x 1/8 - 27 female
- 



- #69-21373 Ohmeda oxygen coupler x D.I.S.S. oxygen male
  - #69-21374 Ohmeda nitrous oxide coupler x D.I.S.S. nitrous oxide male
  - #69-21375 Ohmeda medical air coupler x D.I.S.S. medical air male
  - #69-21376 Ohmeda vacuum coupler x D.I.S.S. vacuum male
- 



- #69-21863 Ohmeda oxygen coupler x D.I.S.S. oxygen female
- #69-21377 Ohmeda nitrous oxide coupler x D.I.S.S. nitrous oxide female
- #69-21864 Ohmeda medical air coupler x D.I.S.S. medical air female
- #69-21378 Ohmeda vacuum coupler x D.I.S.S. vacuum female
- #69-21596 Ohmeda WAGD coupler x D.I.S.S. WAGD female hand nut

# Adapters/Fittings/Oxequip Med\*Star Style



- #69-20560 Oxequip WAGD Med\*Star adapter x 1/8 - 27 male
- #69-20561 Oxequip WAGD Med\*Star adapter x 1/4 - 18 male
- #69-20558 Oxequip carbon dioxide Med\*Star adapter x 1/8 - 27 male
- #69-20559 Oxequip carbon dioxide Med\*Star adapter x 1/4 - 18 male
- #69-20291 Oxequip oxygen Med\*Star adapter x 1/8 - 27 male
- #69-20295 Oxequip oxygen Med\*Star adapter x 1/4 - 18 male
- #69-20292 Oxequip nitrous oxide Med\*Star adapter x 1/8 - 27 male
- #69-20296 Oxequip nitrous oxide Med\*Star adapter x 1/4 - 18 male
- #69-20293 Oxequip medical air Med\*Star adapter x 1/8 - 27 male
- #69-20297 Oxequip medical air Med\*Star adapter x 1/4 - 18 male
- #69-20294 Oxequip vacuum Med\*Star adapter x 1/8 - 27 male
- #69-20298 Oxequip vacuum Med\*Star adapter x 1/4 - 18 male



- #69-20562 Oxequip WAGD Med\*Star adapter x WAGD D.I.S.S. male
- #69-20301 Oxequip oxygen Med\*Star adapter x oxygen D.I.S.S. male
- #69-20302 Oxequip nitrous oxide Med\*Star adapter x nitrous oxide D.I.S.S. male
- #69-20303 Oxequip medical air Med\*Star adapter x medical air D.I.S.S. male
- #69-20304 Oxequip vacuum Med\*Star adapter x vacuum D.I.S.S. male
- #69-20563 Oxequip carbon dioxide Med\*Star adapter x carbon dioxide D.I.S.S. male



- #69-21452 Oxequip oxygen Med\*Star adapter x 1/8-27 female
- #69-21453 Oxequip nitrous oxide Med\*Star adapter x 1/8-27 female
- #69-21454 Oxequip medical air Med\*Star adapter x 1/8-27 female
- #69-21455 Oxequip vacuum Med\*Star adapter x 1/8-27 female
- #69-21456 Oxequip carbon dioxide Med\*Star adapter x 1/8-27 female
- #69-21457 Oxequip WAGD Med\*Star adapter x 1/8-27 female



- #69-21458 Oxequip oxygen Med\*Star x D.I.S.S. oxygen female
- #69-21459 Oxequip nitrous oxide Med\*Star adapter D.I.S.S. nitrous oxide female
- #69-21460 Oxequip medical air Med\*Star adapter x D.I.S.S. medical air female
- #69-21461 Oxequip vacuum Med\*Star adapter x D.I.S.S. vacuum female
- #69-21462 Oxequip carbon dioxide Med\*Star adapter x D.I.S.S. carbon dioxide female
- #69-21463 Oxequip WAGD Med\*Star adapter x D.I.S.S. WAGD female



- #69-20306 Oxequip oxygen Med\*Star adapter x 90° oxygen D.I.S.S. male
- #69-20307 Oxequip nitrous oxide Med\*Star adapter x 90° nitrous oxide D.I.S.S. male
- #69-20308 Oxequip medical air Med\*Star adapter x 90° medical air D.I.S.S. male
- #69-20309 Oxequip vacuum Med\*Star x 90° vacuum D.I.S.S. male



- #69-21824 Oxequip oxygen Med\*Star adapter x 1/4" hose barb
- #69-21827 Oxequip nitrous oxide Med\*Star adapter x 1/4" hose barb
- #69-21826 Oxequip medical air Med\*Star adapter x 1/4" hose barb
- #69-21825 Oxequip vacuum Med\*Star adapter x 1/4" hose barb
- #69-21341 Oxequip carbon dioxide Med\*Star adapter x 1/4" hose barb
- #69-21828 Oxequip WAGD Med\*Star adapter x 1/4" hose barb



- #69-21893 Oxequip oxygen Med\*Star wye style duplex male adapter inlet x two Med\*Star couplers
- #69-21465 Oxequip medical air Med\*Star wye style duplex male adapter inlet x two Med\*Star couplers
- #69-21894 Oxequip vacuum Med\*Star wye style duplex male inlet x two Med\*Star couplers

Note: Med\*Star checks accept the original Oxequip twist style adapters, referred to as OES or 07 adapter - but original Oxequip OES checks or outlets do NOT accept Med\*Star adapters.

# Adapters/Fittings/Oxequip O.E.S. (07) Style



- #69-20151 Oxequip oxygen adapter x D.I.S.S. oxygen male
- #69-20152 Oxequip nitrous oxide adapter x D.I.S.S. nitrous oxide male
- #69-20153 Oxequip medical air adapter x D.I.S.S. medical air male
- #69-20154 Oxequip vacuum adapter x D.I.S.S. vacuum male
- #69-20951 Oxequip carbon dioxide adapter x D.I.S.S. carbon dioxide male
- #69-20952 Oxequip nitrogen adapter x D.I.S.S. nitrogen male
- #69-21316 Oxequip WAGD adapter x D.I.S.S. WAGD male



- #69-20155 Oxequip oxygen adapter x 1/8 - 27 male
- #69-21317 Oxequip oxygen adapter x 1/4 - 18 male
- #69-20156 Oxequip nitrous oxide adapter x 1/8 - 27 male
- #69-21319 Oxequip nitrous oxide adapter x 1/4 - 18 male
- #69-20157 Oxequip medical air adapter x 1/8 - 27 male
- #69-21318 Oxequip medical air adapter x 1/4 - 18 male
- #69-20158 Oxequip vacuum adapter x 1/8 - 27 male
- #69-21320 Oxequip vacuum adapter x 1/4 - 18 male
- #69-20953 Oxequip carbon dioxide adapter x 1/8 - 27 male
- #69-20954 Oxequip carbon dioxide adapter x 1/4 - 18 male
- #69-20955 Oxequip nitrogen adapter x 1/8 - 27 male
- #69-20956 Oxequip nitrogen adapter x 1/4 - 18 male



- #69-20284 Oxequip oxygen adapter x D.I.S.S. oxygen female
- #69-21321 Oxequip nitrous oxide adapter x D.I.S.S. nitrous oxide female
- #69-21322 Oxequip medical air adapter x D.I.S.S. medical air female
- #69-21323 Oxequip vacuum adapter x D.I.S.S. vacuum female
- #69-21324 Oxequip carbon dioxide adapter x D.I.S.S. carbon dioxide female
- #69-21325 Oxequip nitrogen adapter x D.I.S.S. nitrogen female
- #69-21326 Oxequip WAGD adapter x D.I.S.S. WAGD female



- #69-20285 Oxequip oxygen adapter x 90° elbow D.I.S.S. oxygen male
- #69-20286 Oxequip nitrous oxide adapter x 90° elbow D.I.S.S. nitrous oxide male
- #69-20287 Oxequip medical air adapter x 90° elbow D.I.S.S. medical air male
- #69-20288 Oxequip vacuum adapter x 90° elbow D.I.S.S. vacuum male



- #69-21597 Oxequip carbon dioxide check x D.I.S.S. carbon dioxide male
- #69-20949 Oxequip WAGD check x D.I.S.S. WAGD male
- #69-20419 Oxequip oxygen check x D.I.S.S. oxygen male
- #69-20420 Oxequip nitrous oxide check x D.I.S.S. nitrous oxide male
- #69-20421 Oxequip medical air check x D.I.S.S. medical air male
- #69-20422 Oxequip vacuum check x D.I.S.S. vacuum male
- #69-20159 Oxequip oxygen check x 1/4 -18 male
- #69-20161 Oxequip medical air check x 1/4 - 18 male
- #69-20162 Oxequip vacuum check x 1/4 - 18 male
- #69-20160 Oxequip nitrous oxide check x 1/4 - 18 male



- #69-21333 Oxequip oxygen adapter x 1/4" hose barb
- #69-21334 Oxequip nitrous oxide adapter x 1/4" hose barb
- #69-21335 Oxequip medical air adapter x 1/4" hose barb
- #69-21336 Oxequip vacuum adapter x 1/4" hose barb



- #69-21327 Oxequip oxygen adapter x 1/8 - 27 female
- #69-21328 Oxequip nitrous oxide adapter x 1/8 - 27 female
- #69-21329 Oxequip medical air adapter x 1/8 - 27 female
- #69-21330 Oxequip vacuum adapter x 1/8 - 27 female
- #69-21331 Oxequip carbon dioxide adapter x 1/8 - 27 female
- #69-21332 Oxequip nitrogen adapter x 1/8 - 27 female

**Note:** Med\*Star checks accept the original Oxequip twist style adapters, referred to as OES or 07 adapter - but original Oxequip OES checks or outlets do NOT accept Med\*Star adapters.

# Adapters/Fittings/Puritan-Bennett



- #69-20163 Puritan oxygen adapter x 1/4" hose barb
- #69-20164 Puritan nitrous oxide adapter x 1/4" hose barb
- #69-20165 Puritan medical air adapter x 1/4" hose barb
- #69-20166 Puritan vacuum adapter x 1/4" hose barb
- #69-21520 Puritan vacuum adapter x 5/16" hose barb
- #69-20396 Puritan WAGD adapter x 5/16" hose barb



- #69-21481 Puritan WAGD adapter x 1/4" hose barb
- #69-20167 Puritan type oxygen check x 1/4" hose barb
- #69-20168 Puritan type nitrous oxide check x 1/4" hose barb
- #69-20169 Puritan type medical air check x 1/4" hose barb
- #69-20170 Puritan type vacuum check x 1/4" hose barb
- #69-21518 Puritan type vacuum check x 5/16" hose barb
- #69-20397 Puritan type WAGD check x 1/4" hose barb
- #69-21519 Puritan type WAGD check x 5/16" hose barb



- #69-20355 Puritan oxygen adapter x 1/4 - 18 male
- #69-20171 Puritan oxygen adapter x 1/8 - 27 male
- #69-21307 Puritan nitrous oxide adapter x 1/8 - 27 male
- #69-20172 Puritan nitrous oxide adapter x 1/4 - 18 male
- #69-20173 Puritan medical air adapter x 1/4 - 18 male
- #69-21308 Puritan medical air adapter x 1/8 - 27 male
- #69-20174 Puritan vacuum adapter x 1/8 - 27 male
- #69-20356 Puritan vacuum adapter x 1/4 - 18 male
- #69-21248 Puritan WAGD adapter x 1/4 - 18 male
- #69-21545 Puritan WAGD adapter x 1/8 - 27 male



- #69-21309 Puritan nitrous oxide adapter x 1/8 - 27 female
- #69-21310 Puritan medical air adapter x 1/8 - 27 female
- #69-20274 Puritan oxygen adapter x 1/8 - 27 female
- #69-21311 Puritan vacuum adapter x 1/8 - 27 female
- #69-21546 Puritan WAGD adapter x 1/8 - 27 female



- #69-20275 Puritan oxygen adapter x oxygen D.I.S.S. male
- #69-20276 Puritan vacuum adapter x vacuum D.I.S.S. male
- #69-20398 Puritan medical air adapter x medical air D.I.S.S. male
- #69-20621 Puritan nitrous oxide adapter x nitrous oxide D.I.S.S. male
- #69-21544 Puritan WAGD adapter x D.I.S.S. male



- #69-20277 Puritan type oxygen check x 1/4 - 18 male
- #69-20278 Puritan type nitrous oxide check x 1/4 - 18 male
- #69-20279 Puritan type medical air check x 1/4 - 18 male
- #69-20280 Puritan type vacuum check 1/4 - 18 male
- #69-21250 Puritan type WAGD check x 1/4 - 18 male



- #69-21608 Puritan WAGD duplex adapter, Puritan inlet stem and (2) Puritan check outlets
- #69-20281 Puritan oxygen duplex adapter, Puritan inlet stem and (2) Puritan check outlets
- #69-20282 Puritan medical air duplex adapter, Puritan inlet stem and (2) Puritan check outlets
- #69-20357 Puritan vacuum duplex adapter, Puritan inlet stem and (2) Puritan check outlets



- #69-21312 Puritan oxygen adapter x D.I.S.S. oxygen female
- #69-21313 Puritan nitrous oxide adapter x D.I.S.S. nitrous oxide female
- #69-21314 Puritan medical air adapter x D.I.S.S. medical air female
- #69-21315 Puritan vacuum adapter x D.I.S.S. vacuum female
- #69-21547 Puritan WAGD adapter x D.I.S.S. WAGD female

# Adapters/Fittings/Schrader Style

**NON-Swivel DESIGN - Used where positioning is critical - Example: Flowmeters and Suction Regulators**



- #69-20133 Schrader oxygen adapter x 1/8 - 27 male
- #69-20410 Schrader nitrous oxide adapter x 1/8 - 27 male
- #69-20414 Schrader medical air adapter x 1/8 - 27 male\*
- #69-20412 Schrader vacuum adapter x 1/8 - 27 male
- #69-21588 Schrader nitrogen adapter x 1/8 - 27 male



- #69-21387 Schrader oxygen adapter x 1/8 - 27 female
- #69-21388 Schrader nitrous oxide adapter x 1/8 - 27 female
- #69-21389 Schrader medical air adapter x 1/8 - 27 female\*
- #69-21390 Schrader vacuum adapter x 1/8 - 27 female
- #69-21589 Schrader nitrogen adapter x 1/8 - 27 female



- #69-20358 Schrader vacuum adapter x 1/4 - 18 male
- #69-20406 Schrader oxygen adapter x 1/4 - 18 male
- #69-20359 Schrader medical air adapter x 1/4 - 18 male\*
- #69-20411 Schrader nitrous oxide adapter x 1/4 - 18 male



- #69-21413 Schrader oxygen adapter x 1/4" hose barb
- #69-21414 Schrader nitrous oxide adapter x 1/4" hose barb
- #69-21415 Schrader medical air adapter x 1/4" male hose barb\*
- #69-21416 Schrader vacuum adapter x 1/4" hose barb
- #69-21515 Schrader vacuum adapter x 5/16" hose barb
- #69-21592 Schrader nitrogen adapter x 1/4" hose barb



- #69-20132 Schrader oxygen adapter x D.I.S.S. oxygen male
- #69-21236 Schrader nitrous oxide adapter x D.I.S.S. nitrous oxide male
- #69-21237 Schrader medical air adapter x D.I.S.S. medical air male
- #69-21238 Schrader vacuum adapter x D.I.S.S. vacuum male
- #69-21590 Schrader nitrogen adapter x D.I.S.S. nitrogen male



- #69-20416 Schrader oxygen adapter x D.I.S.S. oxygen female
- #69-21417 Schrader nitrous oxide adapter x D.I.S.S. nitrous oxide female
- #69-21418 Schrader medical air adapter x D.I.S.S. medical air female
- #69-21419 Schrader vacuum adapter x D.I.S.S. vacuum female
- #69-21591 Schrader nitrogen adapter x D.I.S.S. nitrogen female



#83-900-0212 Nitrogen Hazard Warning Tag (sold without chain)

**Important Industry Update:**

For years Schrader adapters and check units were not manufactured with nitrogen-specific indexing. In 2004, Schrader released such fittings which are now recommended for all nitrogen-driven products in place of the medical air version adopted by the industry for decades. Please use care when ordering.

\*If used for nitrogen, specific potential hazard warnings should be affixed to device indicating such.

# Adapters/Fittings/Schrader Style

SWIVEL DESIGN - USED ON HOSES AND OTHER ASSEMBLIES WHERE POSITIONING IS NOT REQUIRED



#69-20408

Schrader oxygen adapter x 1/8 - 27 male

#69-20409

Schrader nitrous oxide adapter x 1/8 - 27 male

#69-20413

Schrader medical air adapter x 1/8 - 27 male\*

#69-20404

Schrader vacuum adapter x 1/8 - 27 male

#69-21593

Schrader nitrogen adapter x 1/8 - 27 male



#69-21420

Schrader oxygen adapter x 1/8 - 27 female

#69-21421

Schrader nitrous oxide adapter x 1/8 - 27 female

#69-21422

Schrader medical air adapter x 1/8 - 27 female\*

#69-21423

Schrader vacuum adapter x 1/8 - 27 female

#69-21587

Schrader nitrogen adapter x 1/8 - 27 female



#69-21255

Schrader oxygen adapter x 1/4 - 18 male

#69-21495

Schrader nitrous oxide adapter x 1/4 - 18 male

#69-20415

Schrader medical air adapter x 1/4 - 18 male\*

#69-20405

Schrader vacuum adapter x 1/4 - 18 male

#69-21535

Schrader nitrogen adapter x 1/4 - 18 male



#69-20128

Schrader oxygen adapter x 1/4" hose barb

#69-20129

Schrader nitrous oxide adapter x 1/4" hose barb

#69-20130

Schrader medical air adapter x 1/4" hose barb\*

#69-20131

Schrader vacuum adapter x 1/4" hose barb

#69-21516

Schrader vacuum adapter x 5/16" hose barb

#69-21534

Schrader nitrogen adapter x 1/4" hose barb



#69-21424

Schrader oxygen adapter x D.I.S.S. oxygen male

#69-21425

Schrader nitrous oxide adapter x D.I.S.S. nitrous oxide male

#69-21426

Schrader medical air adapter x D.I.S.S. medical air male

#69-21427

Schrader vacuum adapter x D.I.S.S. vacuum male

#69-21594

Schrader nitrogen adapter x D.I.S.S. nitrogen male



#69-21428

Schrader oxygen adapter x D.I.S.S. oxygen female

#69-21429

Schrader nitrous oxide adapter x D.I.S.S. nitrous oxide female

#69-21430

Schrader medical air adapter x D.I.S.S. medical air female

#69-21431

Schrader vacuum adapter x D.I.S.S. vacuum female

#69-21595

Schrader nitrogen adapter x D.I.S.S. nitrogen female



#83-900-0212 Nitrogen Hazard Warning Tag (sold without chain)

### **Important Industry Update:**

For years Schrader adapters and check units were not manufactured with nitrogen-specific indexing. In 2004, Schrader released such fittings which are now recommended for all nitrogen-driven products in place of the medical air version adopted by the industry for decades. Please use care when ordering.

\*If used for nitrogen, specific potential hazard warnings should be affixed to device indicating such.

# Adapters/Fittings/Schrader Style



- #69-20134 Schrader oxygen check 1/4 - 18 male
- #69-20135 Schrader nitrous oxide check x 1/4 - 18 male
- #69-20136 Schrader medical air check x 1/4 - 18 male\*
- #69-20137 Schrader vacuum check x 1/4 - 18 male
- #69-21533 Schrader nitrogen check x 1/4 -18 male



- #69-21432 Schrader oxygen check x 1/8 - 27 male
- #69-21433 Schrader nitrous oxide check x 1/8 - 27 male
- #69-21434 Schrader medical air check x 1/8 - 27 male\*
- #69-21435 Schrader vacuum check x 1/8 - 27 male



- #69-21436 Schrader oxygen check x 1/4" hose barb
- #69-21437 Schrader nitrous oxide check x 1/4" hose barb
- #69-21438 Schrader medical air check x 1/4" hose barb\*
- #69-21439 Schrader vacuum check x 1/4" hose barb
- #69-21517 Schrader vacuum check x 5/16" hose barb
- #69-21549 Schrader nitrogen check x 1/4" hose barb



- #69-21440 Schrader oxygen check x 1/8 - 27 female
- #69-21441 Schrader nitrous oxide check x 1/8 - 27 female
- #69-21442 Schrader medical air check x 1/8 - 27 female\*
- #69-21443 Schrader vacuum check x 1/8 - 27 female



- #69-21444 Schrader oxygen check x D.I.S.S. oxygen male
- #69-21445 Schrader nitrous oxide check x D.I.S.S. nitrous oxide male
- #69-21446 Schrader medical air check D.I.S.S. medical air male
- #69-21447 Schrader vacuum check x D.I.S.S. vacuum male



- #69-21448 Schrader oxygen check x D.I.S.S. oxygen female
- #69-21449 Schrader nitrous oxide check x D.I.S.S. nitrous oxide female
- #69-21450 Schrader medical air check x D.I.S.S. medical air female
- #69-21451 Schrader vacuum check x D.I.S.S. vacuum female
- #69-21536 Schrader nitrogen check x D.I.S.S. nitrogen female



- #69-20283 Schrader oxygen duplex adapter, Schrader inlet stem and two Schrader check outlets
- #69-20362 Schrader medical air duplex adapter, Schrader inlet stem and two Schrader check outlets\*
- #69-20418 Schrader vacuum duplex adapter, Schrader inlet and two Schrader check outlets
- #69-21548 Schrader nitrogen duplex adapter, Schrader inlet stem and two Schrader nitrogen check outlets

\*If used for nitrogen, specific hazard warnings should be affixed to device indicating such, refer to Hazard Warning label #83-900-0212.

# Adapters/Fittings/D.I.S.S.



- #69-20185 Oxygen hex nut
- #69-20186 Nitrous oxide hex nut
- #69-20187 Medical air hex nut
- #69-20188 Vacuum hex nut
- #69-20324 Nitrogen hex nut
- #69-20434 Helium hex nut
- #69-20435 Carbon dioxide hex nut
- #69-20959 WAGD hex nut
- #69-21261 Oxygen-Helium mixture (Heliox) hex nut, helium<80.5% (CGA #1180A)
- #69-21556 Instrument air hex nut



- #69-30200 Oxygen hand nut
- #69-30201 Nitrous oxide hand nut
- #69-30202 Medical air hand nut
- #69-21581 Instrument air hand nut
- #69-30203 Vacuum hand nut
- #69-30204 Nitrogen/ Helium hand nut
- #69-20437 Carbon dioxide hand nut
- #69-20566 WAGD hand nut



- #69-30300 Retaining ring for nitrous oxide, nitrogen, vacuum, medical air carbon dioxide and helium nipple
- #69-30302 Retaining ring for WAGD and instrument air nipple



- #69-20218 Nipple, oxygen x 1/8 - 27 male
- #69-20219 Nipple, nitrous oxide x 1/8 - 27 male
- #69-20220 Nipple, nitrous oxide x 1/4 - 18 male
- #69-20221 Nipple, medical air x 1/8 - 27 male
- #69-20222 Nipple, medical air x 1/4 - 18 male
- #69-20223 Nipple, vacuum x 1/8 - 27 male
- #69-20224 Nipple, vacuum x 1/4 - 18 male
- #69-20322 Nipple, nitrogen x 1/8 - 27 male
- #69-20323 Nipple, nitrogen x 1/4 - 18 male
- #69-20995 Nipple, carbon dioxide x 1/8 - 27 male
- #69-20996 Nipple, carbon dioxide x 1/4 - 18 male
- #69-21491 Nipple, WAGD x 1/8 - 27 male
- #69-21553 Nipple, instrument air x 1/8 - 27 male
- #69-21554 Nipple, instrument air x 1/4 - 18 male



- #69-20432 Oxygen hose barb for 3/16" I.D. hose
- #69-20181 Oxygen hose barb for 1/4" I.D. hose
- #69-20182 Nitrous oxide hose barb for 1/4" I.D. hose
- #69-20183 Medical air hose barb for 1/4" I.D. hose
- #69-20184 Vacuum hose barb for 1/4" I.D. hose
- #69-21501 Vacuum hose barb for 5/16" I.D. hose
- #69-30301 Nitrogen hose barb for 1/4" I.D. hose
- #69-20430 Helium hose barb for 1/4" I.D. hose
- #69-20431 Carbon dioxide hose barb for 1/4" I.D. hose
- #69-20960 WAGD hose barb for 1/4" I.D. hose
- #69-21500 WAGD hose barb for 5/16" I.D. hose
- #69-21262 Oxygen-Helium mixture (Heliox) hose barb for 1/4" I.D. hose, helium<80.5% (CGA #1180A)
- #69-21555 Instrument air hose barb for 1/4" I.D. hose



- #69-21577 Medical Air D.I.S.S. female x 90° pivoting elbow with 1/4" hose barb
- #69-21578 Oxygen D.I.S.S. female x 90° pivoting elbow with 1/4" hose barb
- #69-21579 Nitrous Oxide D.I.S.S. female x 90° pivoting elbow with 1/4" hose barb
- #69-21580 Vacuum D.I.S.S. female x 90° pivoting elbow with 1/4" hose barb

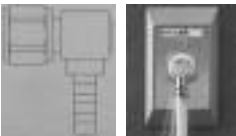

IT PIVOTS!



# Adapters/Fittings/D.I.S.S./Female



Chain with hook



#69-21240	Oxygen handnut and nipple combination for 1/4" I.D. hose
#69-20439	Nitrous oxide handnut and nipple combination for 1/4" I.D. hose
#69-20440	Medical air handnut and nipple combination for 1/4" I.D. hose
#69-21582	Instrument air handnut and nipple for 1/4" I.D. hose
#69-20441	Vacuum handnut and nipple combination for 1/4" I.D. hose
#69-21506	Vacuum handnut and nipple combination for 5/16" I.D. hose
#69-20442	Nitrogen handnut and nipple combination for 1/4" I.D. hose
#69-20701	Helium handnut and nipple combination for 1/4" I.D. hose
#69-20443	Carbon dioxide handnut nipple combination for 1/4" I.D. hose
#69-21245	WAGD handnut and nipple combination for 1/4" I.D. hose
#69-21507	WAGD handnut and nipple combination for 5/16" I.D. hose
#69-21852	95% O <sub>2</sub> , 5% CO <sub>2</sub> handnut and nipple combination for 1/4" I.D. hose
#69-21343	Oxygen nut and nipple combination x 1/8 - 27 male
#69-21344	Nitrous oxide and nipple combination x 1/8 - 27 male
#69-21345	Medical air nut and nipple combination x 1/8 - 27 male
#69-21346	Vacuum nut and nipple combination x 1/8 - 27 male
#69-21347	Carbon dioxide nut and nipple combination x 1/8 - 27 male
#69-21348	WAGD nut and nipple combination x 1/8 - 27 male
#69-21349	Nitrogen nut and nipple combination x 1/8 - 27 male
#69-21350	95% O <sub>2</sub> , 5% CO <sub>2</sub> nut and nipple combination x 1/8 - 27 male
#69-21550	Instrument air nut and nipple combination x 1/8 - 27 male
#69-21551	Instrument air nut and nipple combination x 1/4 - 18 male
#69-20325	Oxygen nut nipple combination for 1/4" I.D. hose
#69-20326	Nitrous oxide nut and nipple combination for 1/4" I.D. hose
#69-20327	Medical air nut and nipple combination for 1/4" I.D. hose
#69-20328	Vacuum nut and nipple combination for 1/4" I.D. hose
#69-21504	Vacuum nut and nipple combination for 5/16" I.D. hose
#69-20329	Nitrogen nut and nipple combination for 1/4" I.D. hose
#69-20700	Helium nut and nipple combination for 1/4" I.D. hose
#69-20438	Carbon dioxide nut and nipple combination for 1/4" I.D. hose
#69-21505	WAGD nut and nipple combination for 5/16" I.D. hose
#69-21246	WAGD nut and nipple combination for 1/4" I.D. hose
#69-21815	95% O <sub>2</sub> , 5% CO <sub>2</sub> nut and nipple combination for 1/4" I.D. hose
#69-21816	Special gas mixture nut and nipple combination for 1/4" I.D. hose (CGA 1020A)
#69-21552	Instrument air nut and nipple combination for 1/4" I.D. hose
#69-21264	Oxygen nut and nipple combination x tapered hose barb, 3/16" to 3/8", with 5" chain and hook
#69-20535	Oxygen D.I.S.S. plug and chain assembly
#69-20993	WAGD D.I.S.S. plug and chain assembly
#69-21247	Common D.I.S.S. plug and chain assembly for nitrous oxide, medical air, vacuum, instrument air and nitrogen
#69-21359	Nitrous oxide handnut and nipple combination x 1/8 - 27 female
#69-21360	Medical air handnut and nipple combination x 1/8 - 27 female
#69-21362	Carbon dioxide handnut and nipple combination x 1/8 - 27 female
#69-21363	WAGD handnut and nipple combination x 1/8 - 27 female
#69-21364	Nitrogen handnut and nipple combination x 1/8 - 27 female
#69-21365	95% O <sub>2</sub> , 5% CO <sub>2</sub> handnut and nipple combination x 1/8 - 27 female
#69-20727	Oxygen D.I.S.S. plastic dust cap w/chain and hook
#69-20728	Oxygen D.I.S.S. plastic dust cap w/chain and eyelet
#69-20729	All other gases D.I.S.S. plastic dust cap w/chain and hook
#69-20730	All other gases D.I.S.S. plastic dust cap w/chain and eyelet
#69-21351	Oxygen handnut and nipple combination x 1/8 - 27 male
#69-21352	Nitrous oxide handnut and nipple combination x 1/8 - 27 male
#69-21353	Medical air handnut and nipple combination x 1/8 - 27 male
#69-21354	Vacuum handnut and nipple combination x 1/8 - 27 male
#69-21355	Carbon dioxide handnut and nipple combination x 1/8 - 27 male
#69-21356	WAGD handnut and nipple combination x 1/8 - 27 male
#69-21357	Nitrogen handnut and nipple combination x 1/8 - 27 male
#69-21358	95% O <sub>2</sub> , 5% CO <sub>2</sub> handnut and nipple combination x 1/8 - 27 male

# Adapters/Fittings/D.I.S.S./Male



- #69-21575 Instrument Air D.I.S.S. check valve w/red hand grip x 1/4" hose barb
- #69-21509 WAGD D.I.S.S. check valve w/purple hand grip x 5/16" hose barb
- #69-21490 WAGD D.I.S.S. check valve w/purple hand grip x 1/4" hose barb
- #69-20879 Oxygen D.I.S.S. check valve w/green hand grip x 1/4" hose barb
- #69-20880 Nitrous oxide D.I.S.S. check valve w/blue hand grip x 1/4" hose barb
- #69-20881 Medical air D.I.S.S. check valve w/yellow hand grip x 1/4" hose barb
- #69-20882 Vacuum D.I.S.S. check valve w/white hand grip x 1/4" hose barb
- #69-21508 Vacuum D.I.S.S. check valve w/white hand grip x 5/16" hose barb
- #69-20883 Nitrogen D.I.S.S. check valve w/black hand grip x 1/4" hose barb
- #69-20998 Carbon dioxide D.I.S.S. check valve w/grey hand grip x 1/4" hose barb



- #69-20884 Oxygen D.I.S.S. male adapter w/green hand grip x 1/4" hose barb
- #69-20885 Nitrous oxide D.I.S.S. male adapter w/blue hand grip x 1/4" hose barb
- #69-20886 Medical air D.I.S.S. male adapter w/yellow hand grip x 1/4" hose barb
- #69-20888 Nitrogen D.I.S.S. male adapter w/black hand grip x 1/4" hose barb
- #69-20994 Carbon dioxide D.I.S.S. male adapter w/grey hand grip x 1/4" hose barb
- #69-20887 Vacuum D.I.S.S. male adapter w/white hand grip x 1/4" hose barb
- #69-21503 Vacuum D.I.S.S. male adapter w/white hand grip x 5/16" hose barb
- #69-21466 WAGD D.I.S.S. male adapter w/purple hand grip x 1/4" hose barb
- #69-21502 WAGD D.I.S.S. male adapter w/purple hand grip x 5/16" hose barb



- #69-20201 Oxygen adapter, D.I.S.S. male x 1/4" hose barb
- #69-30101 Nitrous oxide adapter, D.I.S.S. male x 1/4" hose barb
- #69-30102 Medical air adapter, D.I.S.S. male x 1/4" hose barb
- #69-30103 Vacuum adapter, D.I.S.S. male x 1/4" hose barb
- #69-20330 Nitrogen adapter, D.I.S.S. male x 1/4" hose barb



- #69-20175 Adapter, oxygen D.I.S.S. male x oxygen D.I.S.S. male
- #69-20204 Adapter, oxygen D.I.S.S. male x 1/8 - 27 male
- #69-20177 Adapter, oxygen D.I.S.S. male x 1/4 - 18 male



- #69-20230 Adapter, nitrous oxide D.I.S.S. male x 1/8 - 27 male
- #69-20231 Adapter, nitrous oxide D.I.S.S. male x 1/4 - 18 male
- #69-20232 Adapter, medical air D.I.S.S. male x 1/8 - 27 male
- #69-20233 Adapter, medical air D.I.S.S. male x 1/4 - 18 male
- #69-20234 Adapter, vacuum D.I.S.S. male x 1/8 - 27 male
- #69-20235 Adapter, vacuum D.I.S.S. male x 1/4 - 18 male
- #69-20319 Adapter, nitrogen D.I.S.S. male x 1/8 - 27 male
- #69-20320 Adapter, nitrogen D.I.S.S. male x 1/4 - 18 male
- #69-20428 Adapter, helium D.I.S.S. male x 1/4 - 18 male
- #69-20429 Adapter, carbon dioxide D.I.S.S. male x 1/4 - 18 male
- #69-21571 Adapter carbon dioxide D.I.S.S. male x 1/8 - 27 male
- #69-20961 Adapter, WAGD D.I.S.S. male x 1/4 - 18 male
- #69-21557 Adapter, instrument air D.I.S.S. male 1/8 - 27 male
- #69-21558 Adapter, instrument air D.I.S.S. male x 1/4 - 18 male
- #69-21586 Adapter, Helium-Oxygen (Heliox) D.I.S.S. male (CGA 1180) x 1/4 - 18 male



- #69-20210 Adapter, oxygen D.I.S.S. male x 1/8 - 27 female
- #69-20211 Adapter, oxygen D.I.S.S. male x 1/4 - 18 female



- #69-20236 Adapter, nitrous oxide D.I.S.S. male x 1/8 - 27 female
- #69-20237 Adapter, medical air D.I.S.S. male x 1/8 - 27 female
- #69-20321 Adapter, nitrogen D.I.S.S. male x 1/8 - 27 female
- #69-20238 Adapter, vacuum D.I.S.S. male x 1/8 - 27 female



- #69-21216 Coupler grip 1/8 - 27 NPT female x 1/8 - 27 NPT male - Oxygen
- #69-21217 Coupler grip 1/8 - 27 NPT female x 1/8 - 27 NPT male - Medical Air
- #69-21218 Coupler grip 1/8 - 27 NPT female x 1/8 - 27 NPT male - Vacuum
- #69-21219 Coupler grip 1/8 - 27 NPT female x 1/8 - 27 NPT Male - Nitrous Oxide

# Adapters/Fittings/D.I.S.S. Female X D.I.S.S. Male

---



- #69-20750 - Swivel adapter, 90°, D.I.S.S. oxygen female X 1/8 - 27 female (not shown)
  - #69-20751 - Swivel adapter, 90°, D.I.S.S. oxygen female X 1/4 - 18 female (not shown)
  - #69-20638 - Swivel adapter, 90°, D.I.S.S. oxygen female X 1/8 - 27 male - 1 1/2" long
  - #69-20639 - Swivel adapter, 90°, D.I.S.S. oxygen female X 1/4 - 18 male - 1 1/2" long
- 



- #69-20640 - Swivel adapter, D.I.S.S. oxygen female x 1/8 - 27 female
  - #69-20641 - Swivel adapter, D.I.S.S. oxygen female x 1/4 - 18 female
- 



- #69-20642 - Swivel adapter, D.I.S.S. oxygen female x 1/8 - 27 male
  - #69-20643 - Swivel adapter, D.I.S.S. oxygen female x 1/4 - 18 male
- 



- #69-20178 - Coupling - D.I.S.S. female oxygen x D.I.S.S. female oxygen
- 



- #69-21805 - Swivel elbow, D.I.S.S. female oxygen x D.I.S.S. female oxygen
- 



- #69-20636 - Swivel elbow, D.I.S.S. female oxygen x D.I.S.S. male oxygen (3/4" long)
- #69-20217 - Swivel elbow, D.I.S.S. female oxygen x D.I.S.S. male oxygen (1 1/2" long)
- #69-20637 - Swivel elbow, D.I.S.S. female oxygen x D.I.S.S. male oxygen (2" long)
- #69-20353 - Swivel elbow, D.I.S.S. female medical air x D.I.S.S. male medical air
- #69-21879 - Swivel elbow, D.I.S.S. female vacuum x D.I.S.S. male vacuum



- #69-21260 - Adapter, tee 1/8 - 27 NPT female inlet x two D.I.S.S. female oxygen outlets
- 



- #69-20644 - Oxygen ... D.I.S.S. 1240 Triple Outlet Rail Block w/check valve outlets
- #69-20645 - Nitrous Oxide ... D.I.S.S. 1040-A Triple Outlet Rail Block w/ D.I.S.S. male outlets
- #69-20646 - Medical air ... D.I.S.S. 1160-A Triple Outlet Rail Block w/ D.I.S.S. male outlets
- #69-20647 - Nitrogen ... D.I.S.S. 1120-A Triple Outlet Rail Block w/ D.I.S.S. male outlets
- #69-20648 - Rail block less fittings ... 1/8" NPT female inlet ... (3) 1/4" NPT female outlets w/ mounting bracket
- #69-20649 - Female bracket for wall mounting

# Adapters/Fittings

---



- #69-20193 Oxygen duplex adapter w/o check valves
- #69-20194 Oxygen duplex adapter w/check valves
- #69-20195 Medical air duplex adapter w/o check valves
- #69-20196 Medical air duplex adapter w/check valves
- #69-20197 Vacuum duplex adapter w/o check valves
- #69-20198 Vacuum duplex adapter w/check valves
- #69-20619 Nitrogen duplex adapter w/o check valves
- #69-21806 Nitrogen duplex adapter w/check valves
- #69-20999 Nitrous oxide duplex adapter w/o check valves
- #69-21200 Nitrous oxide duplex adapter w/check valves
- #69-21537 Carbon dioxide duplex adapter w/check valves



- #69-20586 Replacement O-Ring for D.I.S.S. oxygen nipple 10/pk
- #69-20587 Replacement O-Ring for D.I.S.S. nitrous oxide nipple 10/pk
- #69-20588 Replacement O-Ring for D.I.S.S. nitrogen nipple 10/pk
- #69-20589 Replacement O-Ring for D.I.S.S. vacuum nipple 10/pk
- #69-20590 Replacement O-Ring for D.I.S.S. medical air nipple 10/pk
- #69-21489 Replacement O-Ring for D.I.S.S. WAGD nipple 10/pk



- #69-20433 Oxygen hose barb, tapered for 3/16" to 3/8" I.D. hose



- #69-20565 Oxygen wing nut



- #02-6700-0725-800 Vacuum D.I.S.S. male x 1/8 - 27 NPT male with D.I.S.S. vacuum female nut and gland (plastic). Fits "fork" bracket adapters.



- #69-20922 Vacuum D.I.S.S. to stem assembly. This D.I.S.S. female to serrated stem assembly allows the user to mount a suction regulator on the "eye" hook of a floor mount holder. This permits use of the suction regulator on the opening room floor when stem inlet type disposable collection units are preferred. Fits "fork" bracket adapters.

# Adapters/Fittings/Check Valves

#69-20628 - Typical Operation

## DEMAND CHECK VALVES

50 PSI Working Pressure

Demand Check Valve Units are designed for use in D.I.S.S. outlet systems where immediate gas supply (or suction) is desired on demand. Positive shut off is achieved with disconnection of inlet nut and nipple. Demand Check Valve Units are to serve secondary equipment downstream from standard service outlets.

Full free extension of poppet is required for unobstructed full flow pressure when demand check is connected to D.I.S.S. hose nut and nipple. If proper clearance is not possible, then Extension Adapters are necessary. After installation, test for free full flow of pressure prior to operation.

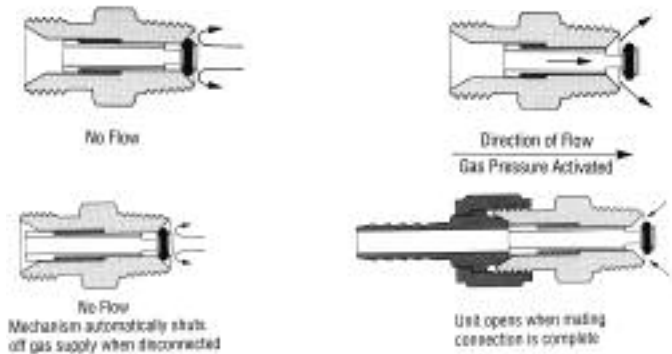

#69-21256 - Typical Operation



- #69-21576 Check valve, instrument air D.I.S.S. male x 1/4 - 18 male
- #69-21256 Check valve, WAGD D.I.S.S. male x 1/4 - 18 male
- #69-20239 Check valve, oxygen D.I.S.S. male x 1/8 - 27 male
- #69-20240 Check valve, oxygen D.I.S.S. male x 1/4 - 18 male
- #69-20241 Check valve, nitrous oxide D.I.S.S. male x 1/8 - 27 male
- #69-20242 Check valve, nitrous oxide D.I.S.S. male 1/4 - 18 male
- #69-20243 Check valve, medical air D.I.S.S. male x 1/8 - 27 male
- #69-20244 Check valve, medical air D.I.S.S. male x 1/4 - 18 male
- #69-20245 Check valve, vacuum D.I.S.S. male x 1/4 - 18 male
- #69-20317 Check valve, nitrogen D.I.S.S. male x 1/8 - 27 male
- #69-20318 Check valve, nitrogen D.I.S.S. male x 1/4 - 18 male
- #69-20997 Check valve, carbon dioxide D.I.S.S. male 1/4 - 18 male
- #69-21259 Check valve, carbon dioxide D.I.S.S. male x 1/8 - 27 male
- #69-21583 Check valve, helium-oxygen, He>80% D.I.S.S. male x 1/8 - 27 male (CGA 1060A)
- #69-21584 Check valve, helium-oxygen, He>80% D.I.S.S. male x 1/4 - 18 male (CGA 1060A)
- #69-21601 Check valve, oxygen-helium, He<80% D.I.S.S. male x 1/8 - 27 male (CGA 1180A)
- #69-21602 Check valve, oxygen-helium, He<80% D.I.S.S. male x 1/4 - 18 male (CGA 1180A)



- #69-20246 Check extension adapter, 1/8 - 27 male x 1/8 - 27 female
- #69-20247 Check extension adapter, 1/4 - 18 male x 1/8 - 27 female
- #69-20248 Check extension adapter, 1/4 - 18 male x 1/4 - 18 female



- #69-20628 Check valve - one way, oxygen D.I.S.S. male x 1/8 - 27 male
- #69-20629 Check valve - one way, oxygen D.I.S.S. male x 1/4 - 18 male
- #69-20630 Check valve - one way, nitrous oxide D.I.S.S. male x 1/8 - 27 male
- #69-20631 Check valve - one way, nitrous oxide D.I.S.S. male x 1/4 - 18 male
- #69-20632 Check valve - one way, medical air D.I.S.S. male x 1/8 - 27 male
- #69-20633 Check valve - one way, medical air D.I.S.S. male x 1/4 - 18 male
- #69-20635 Check valve - one way, nitrogen D.I.S.S. male x 1/4 - 18 male

## CHECK VALVES - CHECK REVERSE FLOW

**Design:** These valves are designed to allow free flow of gas through supply lines and to check any reverse flow. Check valves are opened for full flow at only 4 oz. of gas pressure. If reverse flow occurs - the valve closes instantly with total shut-off at only 10 oz. of back pressure. Check valves are nickel plated.

**Performance:** Check valves have minimum flow volume of 1000 cu. ft/hr. at average of 50 P.S.I. Recommended working pressure not to exceed 125 P.S.I.

**Safety:** Valves should be inspected regularly and replaced when tests indicate faulty operation. Careless usage, dirt or abuse can shorten service life. All check valves are inspected before packaging.



## CGA CONNECTION NO. 1240 OXYGEN

- #69-20553 Oxygen 9/16" - 18 R.H Stationary Female Nut to Male 9/16" - 18 Checks from Female to Male
- #69-20554 Oxygen 9/16" - 18 R.H Male to 9/16" - 18 Female Stationary Nut - Checks from Male to Female
- #69-20555 Oxygen 9/16" - 18 R.H Male to 1/4" NPT Male - Checks from D.I.S.S. side to 1/4" NPT Male
- #69-20556 All Gases 1/4" NPT Male to 1/4" NPT Male
- #69-20557 All Gases 1/4" NPT Female to 1/4" NPT Male - Checks from Female to Male
- #69-20622 All Gases 1/4" NPT Female to 1/4" NPT Male - Checks from Male to Female
- #69-21538 All Gases 1/4" NPT Female to 1/4" NPT Female (not shown)

# Adapters/Fittings/Dynacon Style

---



#69-20310

Dynacon nitrogen coupler x 1/4" hose barb



#69-20311  
#69-21239

Dynacon nitrogen coupler x 1/4 - 18 male  
Dynacon nitrogen coupler x D.I.S.S. female nitrogen  
(not shown)



#32-11-20-0011

Replacement knob for Dynacon nitrogen outlets  
and nitrogen outlets and nitrogen couplers



#69-20584

Dynacon nitrogen adapter x 1/4 - 18 male



#69-20427

Dynacon nitrogen adapter x 1/4" hose barb



#69-20518

Converter, converts Schrader medical air male to  
Dynacon male - nitrogen (w/set screw lock) -  
Converter works on swivel adapters only.

## Gas Driven Power Tool Connectors

These parts are used to connect DISS wall outlets that deliver nitrogen gas to Schrader air fittings used on gas driven power tools

N<sub>2</sub>

Air



#02-0221-0693-800

—

DISS Nut & Gland with Schrader air  
connector assembly for N<sub>2</sub> driver tools  
which use Schrader air fittings



—

#02-0221-0694-800

Connector assembly, 1/8" NPT female  
to Schrader air female swivel adapter

# Adapters/Fittings

## The Industry's only D.I.S.S. Quick Connect

The patented Zip Nut® is the industry's only available D.I.S.S. quick connect. The segmented thread sections allow the nut to be pushed on. Then a 1/4 turn locks & seals the connection. Zip Nut® can be used anywhere a standard D.I.S.S. nut & nipple combination is used.

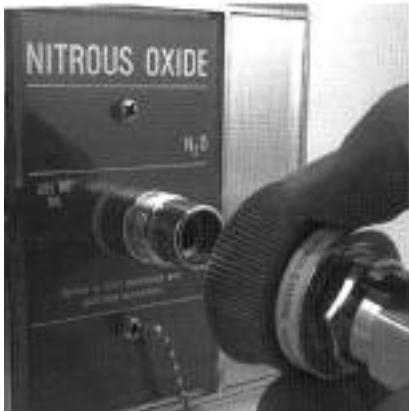





1) Push on threads

2) 1/4 turn seals it

Select inlet connection required from the left hand column

Select gas service requirements from top row



Inlet	Oxygen	Medical Air	Vacuum	N <sub>2</sub> O	WAGD	Nitrogen	Carbon Dioxide
 1/8" MNPT	69-21398	69-21397	69-21561	69-21562	N/A	69-21563	69-21598
 1/4" Hose *5/16" Hose	69-21385	69-21383	69-21384	69-21381	69-21494 69-21564*	69-21382	69-21599
 D.I.S.S. Male	69-21395	69-21393	69-21394	69-21391	69-21396	69-21392	N/A
 1/4" MNPT	N/A	69-21565	69-21566	69-21567	69-21568	69-21569	N/A

# Adapters/Fittings/High Pressure



- #69-20451 Oxygen swivel yoke assy x 1/4 -18 male
- #69-20715 Medical air swivel yoke assy x 1/4 - 18 male



- #69-20723 Nitrous oxide/oxygen yoke assy x 1/4 - 18 male (N<sub>2</sub>O 47.5 - 52.5%)
- #69-20724 Medical diagnostic gas mixture yoke assy x 1/4 -18 male
- #69-20333 Oxygen yoke assy x 1/4 - 18 male
- #69-20334 Nitrous Oxide yoke assy x 1/4 - 18 male
- #69-20335 Medical air Yoke assy x 1/4 - 18 male
- #69-20336 Nitrogen yoke assy x 1/4 - 18 male
- #69-20337 Carbon Dioxide yoke assy x 1/4 - 18 male
- #69-20717 Helium/Oxygen yoke assy x 1/4 - 18 male (HE>80%)
- #69-20718 Helium/Oxygen yoke assy x 1/4 - 18 male (HE<80%)
- #69-20719 Carbon Dioxide/Oxygen yoke assy x 1/4 - 18 male (CO<sub>2</sub> < 7%)

## Existing large cylinder regulator to be used with D/E cylinders. Allows existing large cylinder regulator to be used on small D/E cylinders



- #69-20361 Oxygen Yoke assy to large cylinder connection
- #69-20452 Medical air yoke assy to large cylinder connection
- #69-20453 Nitrous Oxide yoke assy to large cylinder connection
- #69-20454 Nitrogen Yoke assy to large cylinder connection.



- #69-20456 Oxygen yoke assy x 1/4 - 18 male with check valve
- #69-20457 Nitrous oxide yoke assy x 1/4 - 18 male with check valve



#69-20339



#69-21493



#69-21380



#69-20720



#69-21258



#69-20338

- #69-21380 Replacement tee handle with plastic grip wheel
- #69-21412 Replacement tee handle with 6" grip (not shown)
- #69-21258 Replacement tee handle with built in "key" accepting cylinder wrench.  
Eases tightening. (1 3/4" long, 16 threads per inch)
- #69-21493 Replacement rubber yoke washer 10/pkg
- #69-20339 Replacement plastic yoke washers 25/pkg (single use only)
- #69-20338 Replacement tee handle for standard yokes (1 3/4" long, 16 threads per inch)
- #69-20461 Replacement tee handle (2 3/16" long, 16 threads per inch)
- #69-20462 Replacement tee handle(1 3/4" long, 24 threads per inch)
- #69-20720 Replacement yoke adapter x 1/4 - 18 male
- #69-20721 Replacement yoke adapter with check valve x 1/4 -18 male (not shown)
- #69-20722 Replacement yoke adapter x 1/2" NPT male (not shown)



# Adapters/Fittings/High Pressure

## FLEXIBLE STAINLESS STEEL BRAID PIGTAILS\*

(3,000 PSI WORKING PRESSURE; 12,000 PSI BURST PRESSURE)



PART NO.	DESCRIPTION
#69-20481	Medical air large cylinder Pigtail - 18"
#69-20482	Medical air large cylinder Pigtail - 24"
#69-20483	Medical air large cylinder Pigtail - 36"
#69-20484	Medical air large cylinder Pigtail - 48"
#69-20485	Carbon dioxide Large cylinder Pigtail - 18"
#69-20486	Carbon dioxide Large cylinder Pigtail - 24"
#69-20487	Carbon dioxide Large cylinder Pigtail - 36"
#69-20488	Carbon dioxide Large cylinder Pigtail - 48"
#69-20489	Nitrogen large cylinder Pigtail - 18"
#69-20490	Nitrogen large cylinder Pigtail - 24"
#69-20491	Nitrogen large cylinder Pigtail - 36"
#69-20492	Nitrogen large cylinder Pigtail - 48"
#69-20493	Pigtail with 1/4 - 18 female ends - 18"
#69-20494	Pigtail with 1/4 - 18 female ends - 24"
#69-20495	Pigtail with 1/4 - 18 female ends - 36"
#69-20496	Pigtail with 1/4 - 18 female ends - 48"

See following page for Insufflator fittings.

\* Pigtails are also available with check valves. To order check valves, add CV as suffix to product number desired, to receive on inlet side. For check valve on outlet side, add RCV as suffix to product number desired.

Note: Flexible pigtails not recommended for oxygen per NFPA99

## Rigid Chrome Plated Copper Pigtails (18" to 20")

Other configurations available with check valves or shut off valves.



#69-20497	Oxygen pigtail
#69-20498	Nitrous oxide pigtail
#69-20499	Medical air pigtail
#69-20752	Oxygen pigtail with check valve
#69-21467	Carbon dioxide pigtail
#69-21468	Nitrogen/Helium pigtail

## Chrome Plated Brass Coupler Tees



#69-20504	Oxygen tee
#69-20505	Nitrous oxide tee
#69-20506	Medical air tee
#69-20507	Carbon dioxide tee (not chrome plated)
#69-20508	Nitrogen/Helium tee
#69-20753	Oxygen tee with check valve

## Cap And Chain Assembly



#69-20509	Oxygen female cap and chain
#69-20510	Nitrous oxide female cap and chain
#69-20511	Medical air female cap and chain

## USED WITH INSUFFLATOR SYSTEMS



**PART NO.**

**DESCRIPTION**

**#69-21202**

Carbon dioxide Insufflator yoke, 1/4" SAE Flare with 7/16" - 20 thread



**#69-21209**

Insufflator pigtail, 36" length 1/4" SAE Flare with 7/16" - 20 thread, both ends

**#69-21603**

Insufflator pigtail, 24" length 1/4" SAE Flare with 7/16" - 20 thread



**#69-21269**

Adapter, 1/4 SAE Flare Female 7/16" - 20 thread x 1/4" hose barb

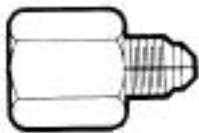

**#69-21267**

Adapter, 1/4 SAE Flare Male 7/16" - 20 thread x 1/4" NPT Female

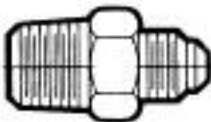

**#69-21268**

Adapter, 1/4 SAE Flare Male 7/16" - 20 thread x 1/4" NPT Male

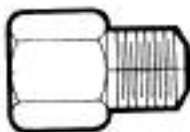

**#69-21270**

Adapter, 1/4 SAE Flare Female 7/16" - 20 thread x 1/4" NPT Male

# Adapters/Fittings/High Pressure



Washer  
↓

PART NO.	DESCRIPTION
#69-21478	Medical mixtures tank nipple with filter
#69-20463	Oxygen tank nipple with filter
#69-20464	Nitrous oxide tank nipple with filter
#69-20465	Medical air tank nipple with filter
#69-20466	Carbon dioxide tank nipple with filter
#69-20467	Helium/nitrogen tank nipple with filter
#69-20468	Oxygen tank nut (CGA 540)
#69-20469	Nitrous oxide tank nut (CGA 326)
#69-20470	Medical air tank nut (CGA 346)
#69-20471	Carbon dioxide tank nut (CGA 320)
#69-20472	Helium/nitrogen tank nut (CGA 580)
#69-21479	Medical mixtures tank nut (CGA 500)
#69-21560	Replacement washer for CO <sub>2</sub> tank nipple

## LARGE CYLINDER CONNECTIONS

### BRASS- NOT CHROME PLATED



#69-20731	Oxygen male valve outlet x 1/4 -18 female
#69-20732	Nitrous oxide male valve outlet x 1/4 - 18 female
#69-20733	Medical air male valve outlet x 1/4 - 18 female
#69-20734	Carbon dioxide male valve outlet x 1/4 - 18 female

### BRASS- NOT CHROME PLATED



#69-20736	Oxygen male valve outlet x 1/4 - 18 male
#69-20738	Medical air male valve outlet x 1/4 - 18 male
#69-20739	Carbon dioxide male valve outlet x 1/4- 18 male
#69-20740	Helium/nitrogen male valve outlet x 1/4 - 18 male
#69-20737	Nitrous oxide male valve outlet x 1/4 - 18 male



#69-21480	Oxygen tank handnut
-----------	---------------------



#69-21542	One-way check valve, 1/4 - 18 NPT male outlet. Supplied with nitrile o-ring (not for oxygen service)
#69-21543	One-way check valve, 1/4 - 18 NPT female inlet x 1/4 - 18 NPT male outlet Supplied with viton o-ring, for use with oxygen service

# Adapters/Fittings

#32-11-30-0004  
#32-11-30-0005

Lock out adapter for oxygen D.I.S.S. outlets  
Lock out adapter for vacuum D.I.S.S. outlets

#32-11-01-0035  
#32-11-01-0036  
#32-11-01-0041

Lock out adapter for Chemetron oxygen connect outlets  
Lock out adapter for Chemetron vacuum quick connect outlets  
Lock out adapter for Chemetron medical air quick connect outlets



#69-21469

Oxygen extension manifold. Two D.I.S.S. oxygen check valves with wall mount flanges. Hose (2') terminates in 1/8 - 27 female elbow

#69-21470

Oxygen extension manifold. Three D.I.S.S. oxygen check valves with wall mount flanges. Hose (2') terminates in 1/8 - 27 female elbow

#69-21471

Oxygen extension manifold. Four D.I.S.S. oxygen check valves with wall mount flanges. Hose (2') terminates in 1/8 - 27 female elbow

#69-218-181

Oxygen extension manifold. Four D.I.S.S. oxygen check valves with wall mount flanges. Hose (3') terminates in oxygen D.I.S.S. handnut on 90° elbow

#69-218-184

Oxygen extension manifold. Two D.I.S.S. oxygen check valves with wall mount flanges. Hose (2') terminates in oxygen D.I.S.S. handnut on 90° elbow

#69-218-177

Oxygen extension manifold. Four D.I.S.S. oxygen check valves with wall mount flanges. Hose (8') terminates in oxygen D.I.S.S. hexnut

#69-218-174

Oxygen extension manifold. Four Chemetron oxygen couplers with wall mount flanges. Hose (3') terminates in Chemetron male adapter on 90° elbow

#69-21472

Medical air extension manifold. Two D.I.S.S. medical air check valves with wall mount flanges. Hose (2') terminates in 1/8 - 27 female elbow

#69-21473

Medical air extension manifold. Three D.I.S.S. medical air check valves with wall mount flanges. Hose (2') terminates in 1/8 - 27 female elbow

#69-21474

Medical air extension manifold. Four D.I.S.S. medical air check valves with wall mount flanges. Hose (2') terminates in 1/8 - 27 female elbow

#69-218178

Medical air extension manifold. Four D.I.S.S. medical air check valves with wall mount flanges. Hose (8') terminates in medical air D.I.S.S. female hexnut

#69-21475

Vacuum extension manifold. Two D.I.S.S. vacuum check valves with wall mount flanges. Hose (2') terminates in 1/8 - 27 female elbow

#69-21476

Vacuum extension manifold. Three D.I.S.S. vacuum check valves with wall mount flanges. Hose (2') terminates in 1/8 - 27 female elbow

#69-21477

Vacuum extension manifold. Four D.I.S.S. vacuum check valves with wall mount flanges. Hose (2') terminates in 1/8 - 27 female elbow

#69-218172

Vacuum extension manifold. Two Ohmeda vacuum couplers with wall mount flanges. Hose (2') terminates in Ohmeda vacuum adapter on 90° elbow

#69-20346

Oxygen large cylinder test gauge

#69-20579

Helium or nitrogen large cylinder test gauge

#69-20580

Carbon Dioxide/oxygen (CO<sub>2</sub> < 7.5%);  
Helium/Oxygen (He < 80.5%) CGA-280;  
Nitrogen/oxygen (O<sub>2</sub> > 23.5%);  
Nitrous oxide/Oxygen (N<sub>2</sub>O 47.5% to 52.5%)  
large cylinder test gauge



#69-20347

Oxygen in-line pressure test gauge, D.I.S.S. connections

#69-20348

Nitrous oxide in-line pressure test gauge, D.I.S.S. connections

#69-20349

Medical air in-line test gauge, D.I.S.S. connections

#69-20350









Vacuum in-line pressure test gauge, D.I.S.S. connections

#69-20582

Nitrogen in-line pressure test gauge, D.I.S.S. connections

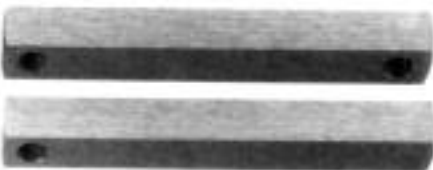

# Adapters/Fittings

	PART NO.	DESCRIPTION
	#69-20650	Plug, 1/8 - 27 male - countersunk
	#69-20651	Plug, 1/4 - 18 male - countersunk
	#69-20957	Cap, 1/8 - 27 female
	#69-20331	Plug, 1/8 - 27 male
	#69-20332	Plug, 1/4 - 18 male
	#69-20540	Close nipple, 1/8 - 27 male x 1/8 - 27 male
	#69-20541	Nipple, 1/8 - 27 male x 1/8 - 27 male - 1 1/2" long
	#69-20542	Nipple, 1/8 - 27 male x 1/8 - 27 male - 2" long
	#69-20543	Nipple, 1/8 - 27 male x 1/8 - 27 male - 2 1/2" long
	#69-20544	Nipple, 1/8 - 27 male x 1/8 - 27 male - 3 1/2" long
	#69-20545	Nipple, 1/4 - 18 male x 1/4 - 18 male - 1 1/2" long
	#69-20546	Nipple, 1/4 - 18 male x 1/4 - 18 male - 2" long
	#69-20547	Nipple, 1/4 - 18 male x 1/4 - 18 male - 2 1/2" long
	#69-20548	Nipple, 1/4 - 18 male x 1/4 - 18 male - 3" long
	#69-20549	Nipple, 1/4 - 18 male x 1/4 - 18 male - 3 1/2" long
	#32-22950-100	Extension adapter, 1/8 - 23 female x 1/8 - 27 male - 1" long
	#69-20550	Extension adapter, 1/8 - 27 female x 1/8 - 27 male - 2 1/2" long
	#69-20551	Extension adapter, 1/4 - 18 female x 1/4 - 18 male - 3" long
	#69-20684	Extension block - two (2) 1/8 - 27 female outlets x one (1) 1/8 - 27 female centered rear inlet (front view shown), 5" long
	#69-20685	Extension block - two (2) 1/8 - 27 female outlets x one (1) 1/8 - 27 female offset rear inlet (rear view shown), 5" long
	<b>NOTE:</b> 2 outlets spaced 4-1/2" on center measurement	
	#69-20687	"L" block, 1/4 - 18 female x 1/8 - 27 female side port
	#69-20691	"L" block, 3 way - 1/4 - 18 female ports, 3" long
	#69-20697	Adapter, elbow - 1/8 - 27 male x 1/8 - 27 female end and 1/8 - 27 female center port
	#69-20726	Adapter, elbow - 1/8 - 27 female end x 1/4 - 27 male with - 1/8 - 27 female center port
<b>Not Shown</b>	#69-21604	Pivot joint - 1/8 - 27 female x 1/8 - 27 male

# Adapters/Fittings

## PART NO. DESCRIPTION



**#69-21541** Elbow adapter, 90° 1/8 - 27 female x 5/16" hose barb

**#69-21492** Elbow adapter, 90° 1/8 - 27 female x 1/4" hose barb

It pivots!

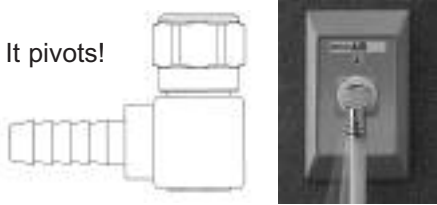

**#69-21539** Pivot adapter, 90° 1/8 - 27 female x 1/4" hose barb

**#69-21540** Pivot adapter, 90° 1/8 - 27 female x 5/16" hose barb



**#69-20176** Coupling - 1/4 - 18 male x 1/4 - 18 male

**#69-20202** Coupling - 1/8 - 27 male x 1/8 - 27 male

**#69-20203** Coupling - 1/8 - 27 male x 1/4 - 18 male



**#69-20205** Coupling - 1/8 - 27 female x 1/8 - 27 female

**#69-20206** Coupling - 1/8 - 27 female x 1/4 - 18 female

**#69-20207** Coupling - 1/4 - 18 female x 1/4 - 18 female



**#69-20179** Adapter, 1/8 - 27 female x 1/4" hose barb

**#69-20180** Adapter, 1/4 - 18 female x 1/4" hose barb

**#69-21523** Adapter, 1/4 - 18 female x 5/16" hose barb



**#69-21522** Adapter, 1/8 - 27 male x 5/16" hose barb

**#69-20199** Adapter, 1/8 - 27 male x 1/4" hose barb

**#69-20200** Adapter, 1/4 - 18 male x 1/4" hose barb

**#69-21521** Adapter, 1/4 - 18 male x 5/16" hose barb



**#69-20444** Bubble hose nipple, 1/4" hose barb x 1/8 - 27 male



**#69-20681** Hose splicer 1/8" hose barb x 1/8" hose barb

**#69-20249** Hose splicer 3/16" hose barb x 3/16" hose barb

**#69-20250** Hose splicer 1/4" hose barb x 1/4" hose barb



**#69-20208** Adapter, 1/8 - 27 female x 1/4 - 18 male

**#69-20209** Adapter, 1/4 - 18 female x 1/8 - 27 male

















**#69-21201** Bulk head assembly x 1/8 - 27 female



**#69-20986** Drop ear, tee 1/8 - 27 female x 1/8 - 27 female x 1/8 - 27 female

**#69-20987** Drop ear, elbow 1/8 - 27 female x 1/8 - 27 female

# Adapters/Fittings/Miscellaneous Elbows, Tees, Wyes

	PART NO.	DESCRIPTION
	#69-20682	Adapter - elbow, 1/8 - 27 male x 1/4" hose barb
	#69-20683	Adapter - elbow, 1/4 - 18 male x 1/4" hose barb
	#69-20212	Elbow, 1/8 - 27 female x 1/8 - 27 male
	#69-20213	Elbow, 1/4 - 18 female x 1/8 - 27 male
	#69-20214	Elbow, 1/4 - 18 female x 1/4 - 18 male
	#69-20702	Elbow, 1/8 - 27 female x 1/8 - 27 male, 45°
	#69-20703	Elbow, 1/4 - 18 female x 1/4 - 18 male, 45°
	#69-20215	Elbow, 1/8 - 27 female x 1/8 - 27 female
	#69-20216	Elbow, 1/4 - 18 female x 1/4 - 18 female
	#69-20225	Tee, three-way - 1/8 - 27 x 1/8 - 27 x 1/8 - 27 female
	#69-20226	Tee, three-way - 1/4 - 18 x 1/4 - 18 x 1/4 - 18 female
	#69-20445	Branch tee, 1/8 - 27 female x 1/8 - 27 male x 1/8 - 27 female
	#69-20446	Branch tee, 1/4 - 18 female x 1/4 - 18 male x 1/4 - 18 female
	#69-20447	Street tee, 1/8 - 27 female x 1/8 - 27 female x 1/8 - 27 male
	#69-20448	Street tee, 1/4 - 18 female x 1/4 - 18 female x 1/4 - 18 male
	#69-20449	Cross, 1/8 - 27 female
	#69-20450	Cross, 1/4 - 18 female
	#69-20652	WYE BLOCK, female 1/8 - 27 inlet x two female 1/4 - 18 outlet
	#69-20653	WYE BLOCK, female 1/8 - 27 inlet x two female 1/8 - 27 outlet
	#69-20360	WYE BLOCK, female 1/4 - 18 inlet x two female 1/4 - 18 outlet
	#69-20227	WYE, male 1/4 - 18 inlet x two female 1/4 - 18 outlet
	#69-20228	WYE, female 1/8 - 27 inlet x two female 1/4 - 18 outlet
	#69-20229	WYE, D.I.S.S. female oxygen inlet x two female 1/4 - 18 outlet
	#69-20654	WYE, D.I.S.S. female oxygen inlet x two D.I.S.S. male oxygen outlet
	#69-21234	WYE, 1/8 - 27 NPT female x Double 1/8 - 27 NPT female
	#69-21235	WYE, 1/8 - 27 NPT female x Double 1/4 - 18 NPT female
	#69-21386	Manifold block, with (6) 1/4 - 18 NPT female ports
	#69-21570	Quad block 14 - 18 female ports

# Adapters/Fittings/Miscellaneous



#69-21220



#69-21221



#69-21249

PART NO.	DESCRIPTION
#69-21249	OHMEDA male vacuum connector x 1/8 - 27 male
#69-21220	OHMEDA trap bottle connector straight x 1/8 - 27 male
#69-21221	OHMEDA trap bottle connector 45° - angle x 1/8 - 27 male
#69-21229	Vacuum Black Type on White
#69-21232	WAGD Black Type on Purple
#69-21231	N <sub>2</sub> O Black Type on Blue
#69-21230	Medical Air Black Type on Yellow
#69-21228	O <sub>2</sub> Black Type on Green adhesive backed aluminum plate 3" w x 1-1/2" h



#69-21257

Pole clamp, 1/8 - 27 female port on side and 1/8 - 27 female port on bottom for poles up to 1" in diameter.

#69-21532

Pole clamp, 1/8 - 27 female port on side and 1/8 - 27 female port on bottom for poles up to 1-1/2" in diameter.





# Adapters/Fittings/Neub Drive & Rescue Flow

## NEB DRIVE

Economical convenient adapter that delivers a preset flow from standard wall outlets. A dependable way to administer aerosol treatments without the need of a flowmeter.

### Ohmeda (type)



NEB DRIVE STOCK #		
Flowrate	O <sub>2</sub>	Medical Air
6 to 7 LPM	69-20764	69-20782
7 to 8 LPM	69-20765	69-20783
8 to 9 LPM	69-20766	69-20784
10 to 11 LPM	69-20964	69-20965

RESCUE FLOW STOCK #	
14-16 LPM	69-20892
24-26 LPM	69-20898

(see Ohmeda style below)

### DISS Female



NEB DRIVE STOCK #		
Flowrate	O <sub>2</sub>	Medical Air
6 to 7 LPM	69-20770	69-20788
7 to 8 LPM	69-20771	69-20789
8 to 9 LPM	69-20772	69-20790
10 to 11 LPM	69-20968	69-20969

RESCUE FLOW STOCK #	
14-16 LPM	69-20891
24-26 LPM	69-20897

(see Ohmeda style below)

### Schrader (type)



NEB DRIVE STOCK #		
Flowrate	O <sub>2</sub>	Medical Air
6 to 7 LPM	69-20776	69-20794
7 to 8 LPM	69-20777	69-20795
8 to 9 LPM	69-20778	69-20796
10 to 11 LPM	69-20972	69-20973

RESCUE FLOW STOCK #	
14-16 LPM	69-20896
24-26 LPM	69-20902

(see Ohmeda style below)

### Rescue Flow (Ohmeda Style Shown)



## RESCUE FLOW

The "Rescue Flow" is designed to save you time and effort when hooking up your resuscitation bag. The "Rescue Flow" gives a restricted flow of 15 LPM or 25 LPM \* from a 50 psi oxygen source and is so small it fits easily on your crash cart.

### Chemetron (NCG) (type)



NEB DRIVE STOCK #		
Flowrate	O <sub>2</sub>	Medical Air
6 to 7 LPM	69-20767	69-20785
7 to 8 LPM	69-20768	69-20786
8 to 9 LPM	69-20769	69-20787
10 to 11 LPM	69-20966	69-20967

RESCUE FLOW STOCK #	
14-16 LPM	69-20893
24-26 LPM	69-20899

(see Ohmeda style below)

### Puritan-Bennett (type)



NEB DRIVE STOCK #		
Flowrate	O <sub>2</sub>	Medical Air
6 to 7 LPM	69-20773	69-20791
7 to 8 LPM	69-20774	69-20792
8 to 9 LPM	69-20775	69-20793
10 to 11 LPM	69-20970	69-20971

RESCUE FLOW STOCK #	
14-16 LPM	69-20894
24-26 LPM	69-20900

(see Ohmeda style below)

### Oxequip (type)



NEB DRIVE STOCK #		
Flowrate	O <sub>2</sub>	Medical Air
6 to 7 LPM	69-20779	69-20797
7 to 8 LPM	69-20780	69-20798
8 to 9 LPM	69-20781	69-20799
10 to 11 LPM	69-20974	69-20975

RESCUE FLOW STOCK #	
14-16 LPM	69-20895
24-26 LPM	69-20901

(see Ohmeda style below)

### Med\*Star (type)



NEB DRIVE STOCK #		
Flowrate	O <sub>2</sub>	Medical Air
6 to 7 LPM	69-20976	69-20980
7 to 8 LPM	69-20977	69-20981
8 to 9 LPM	69-20978	69-20982
10 to 11 LPM	69-20979	69-20983

RESCUE FLOW STOCK #	
14-16 LPM	69-20984
24-26 LPM	69-20985

(see Ohmeda style to left)

\*High flow adapter (25 LPM) recommended for use with Laerdal resuscitators & Mercury Disposable CPR Bags.

# Adapters/Fittings/Valves

---



#69-21222

Wye block w/shut off  
1/8 - 27 female inlet x (2) 1/8 - 27 female outlets

---



#69-21223

1/4 - 18 female x 1/4 - 18 female

#69-21224

1/8 - 27 female x 1/8 - 27 female

---



## NPT Male to Male

#69-21203

1/8 - 27 male inlet, 1/8 - 27 male outlet

#69-21204

1/4 - 18 male inlet, 1/4 - 1/8 male outlet

---



## NPT Female to Female

#69-21205

1/8 - 27 female inlet, 1/8 - 27 female outlet

#69-21206

1/4 - 18 female inlet, 1/4 - 18 female outlet

---



## NPT Male to NPT Female

#69-21207

1/8 - 27 male inlet, 1/8 - 27 female outlet

#69-21208

1/4 - 18 male inlet, 1/4 - 18 female outlet

---

Compact Valves

250 psi max.

Featuring 1/4 turn shutoff for quick and visual on/off status. Full flow construction for optimum performance.

Durable, chrome plated-brass body. Non-corrosive service.

# Adapters/Fittings/Valves

## VALVES

### BALL SEAT SHUT - OFF VALVES

Chrome plated brass bodies, Teflon packing, and stainless steel stems with hardened steel balls for efficient, durable use. Large knurled knob for easy operation. \*For pressures up to 200 PSI. \*\*For pressures up to 3,000 PSI.



- #69-20623\* Valve, 1/4 - 18 male inlet x D.I.S.S. male oxygen outlet
- #69-20624\*\* Valve, 1/8 - 27 male inlet x 1/8 - 27 male outlet
- #69-20625\*\* Valve, 1/8 - 27 female inlet x 1/8 - 27 female outlet
- #69-20626\*\* Valve, 1/4 - 18 male inlet x 1/4 - 18 male outlet
- #69-20627\*\* Valve, 1/4 - 18 male inlet x 1/4 - 18 female outlet



- #69-20680\* Dual valve block, D.I.S.S. oxygen female x (2) D.I.S.S. oxygen male outlet w/valves



- #69-20256\* Valve, D.I.S.S. oxygen female inlet x D.I.S.S. male oxygen outlet
- #69-20257\*\* Valve, 1/4 - 18 male inlet x 1/4 - 18 male outlet
- #69-20258\*\* Valve, 1/8 - 27 male inlet x 1/8 - 27 male outlet
- #69-20259\*\* Valve, 1/4 - 18 male inlet x 1/4 - 18 female outlet
- #69-20260\*\* Valve, 1/4 - 18 female inlet x 1/4 - 18 male outlet
- #69-20261\*\* Valve, 1/8 - 27 female inlet x 1/8 - 27 female outlet
- #69-20655\* Valve, D.I.S.S. oxygen male inlet x 1/4 - 18 male outlet
- #69-20656\* Valve, 1/4 - 18 male inlet x D.I.S.S. oxygen male outlet
- #69-20657\* Valve, D.I.S.S. oxygen male inlet x D.I.S.S. oxygen male outlet



- #69-20400 Quick shut-off valve for vacuum, 1/8 - 27 female x 1/8 - 27 male

## Stainless Steel Cartridge Valves

(REPLACEABLE CARTRIDGES)

- 316 Stainless Steel Body & Cartridge Seals
- Teflon® TFE & 316 SS Packing
- Machined KEL - F® Soft Tip
- Teflon® TFE Cartridge Seals
- -65° to 250° F

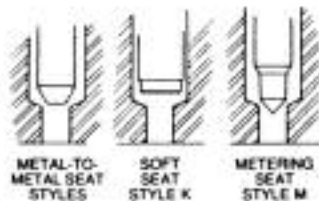

### Choose From Three Seat Styles!

Each offering positive shut-off. Seat style K delivers soft-off action with minimal force. Seat style M provides a fine stem movement for accurate gas flow metering. Seat style S is recommended for firm shut-off in corrosive gas applications.



Styles M and S features 7-Bar Handle

1/4 - 18 male x 1/4 - 18 male

- #69-20671 Soft seal type K, 3000 PSI
- #69-20672 Metering seat Style M, 6000 PSI
- #69-20673 Metal-to-metal seat style S, 6000 PSI

1/4 - 18 male 90° x 1/4 - 18 male

- #69-20674 Soft seal type K, 3000 PSI
- #69-20675 Metering seat style M, 6000 PSI
- #69-20676 Metal-to-metal seat style S, 6000 PSI

1/4 - 18 female x 1/4 - 18 female

- #69-20677 Soft seal type K, 3000 PSI
- #69-20678 Metering seat style M, 6000 PSI
- #69-20679 Metal-to-metal seat style S, 6000 PSI





































# Adapters/Fittings/Wye Adapters

## MISCELLANEOUS WYE CONFIGURATIONS



- #69-20903** Oxygen duplex adapter - Chemetron male oxygen inlet x two (2) D.I.S.S. male oxygen check valves.
- #69-20904** Medical air duplex adapter - Chemetron male medical air inlet x two (2) D.I.S.S. male medical air check valves.
- #69-20905** Vacuum duplex adapter - Chemetron male vacuum inlet x two (2) D.I.S.S. male vacuum check valves.
- #69-20906** Oxygen duplex adapter - OHMEDA male oxygen inlet x two (2) D.I.S.S. male oxygen check valves
- #69-20907** Medical air duplex adapter - OHMEDA male medical air inlet x two (2) D.I.S.S. male medical air check valves
- #69-20908** Vacuum duplex adapter - OHMEDA male vacuum inlet x two (2) D.I.S.S. male vacuum check valves
- #69-20909** Oxygen duplex adapter - Oxequip 07 male oxygen inlet x two (2) D.I.S.S. male oxygen check valves
- #69-20910** Medical air duplex adapter - Oxequip 07 male medical air inlet x two (2) male medical air check valves
- #69-20911** Vacuum duplex adapter - Oxequip 07 male vacuum inlet x two (2) D.I.S.S. male vacuum check valves.
- #69-20912** Oxygen duplex adapter - Oxequip Med\*Star male oxygen inlet x two (2) D.I.S.S. male oxygen check valves
- #69-20913** Medical air duplex adapter - Oxequip Med\*Star male medical air inlet x two (2) D.I.S.S. male check medical air valves
- #69-20914** Vacuum duplex adapter - Oxequip Med\*Star male vacuum inlet x two (2) D.I.S.S. male vacuum check valves
- #69-20915** Oxygen duplex adapter - Puritan-Bennett male oxygen inlet x two (2) D.I.S.S. male oxygen check valves
- #69-20916** Medical air duplex adapter - Puritan-Bennett male medical air inlet x two (2) D.I.S.S. male medical air check valves
- #69-20917** Vacuum duplex adapter - Puritan-Bennett male vacuum inlet x two (2) D.I.S.S. male vacuum check valves
- #69-20918** Oxygen duplex adapter - Schrader male oxygen inlet x two (2) D.I.S.S. male oxygen check valves
- #69-20919** Medical air duplex adapter - Schrader male medical air inlet x two (2) D.I.S.S. male medical air check valves
- #69-20920** Vacuum duplex adapter - Schrader male vacuum inlet x two (2) D.I.S.S. male vacuum check valves

# Hoses/Assemblies (Low Pressure)

A		B	
1	 Ohmeda Type (Ohio Female)	Chemetron (NCG) Male	 8
2	 Chemetron (NCG) Female	Puritan Male	 9
3	 Schrader Female	Schrader Male	 10
4	 Female D.I.S.S. (Hex Nut)	Oxequip Male (O.E.S.)	 11
5	 Male D.I.S.S.	Female D.I.S.S. (Hex Nut)	 12
6	 Oxequip Female	Male D.I.S.S.	 13
16	 Puritan Female	Ohmeda Type (Ohio Diamond)	 14
18	 Color Coded Handnut Female D.I.S.S.	Color-Coded Handnut Female D.I.S.S.	 17
20	 Dynacon Female (N2 only)	Dynacon Male (Nitrogen Only)	 19
24	 Male D.I.S.S. w/Check and Hand Nut Grip	Oxequip Med* Star	 21
26	 Same as above less check valve	Male D.I.S.S. w/Check and Hand Nut Grip	 25
28	 1/4 NPT Female	Same as above Less Check Valve	 27
30	 Color coded "zip" Hand Nut Female D.I.S.S.	1/4 NPT Female	 29
32	 1/4 NPT Male	Color coded "zip" Hand Nut Female D.I.S.S.	 31
34	 1/8 NPT Female	1/4 NPT Male	 33
36	 1/8 NPT Male	1/8 NPT Female	 35
38	 7/16" Female Flare (CO <sub>2</sub> only)	1/8 NPT Male	 37
39	 Rectus Female	Rectus Male	 40

S = Special Fitting

X = No Fitting

**3 Steps to easy ordering**

**1<sup>st</sup> Step: Gas Service**

0. = O<sub>2</sub> (Oxygen)
1. = N<sub>2</sub>O (Nitrous Oxide)
2. = Vac
3. = Medical Air
4. = N<sub>2</sub> (Nitrogen)
5. = WAGD (formerly evacuation)
6. = CO<sub>2</sub> (Carbon Dioxide)
7. = Special Assembly
8. = Instrument AIR
9. = Heliox

**2<sup>nd</sup> Step: Length Desired in Feet**

**3<sup>rd</sup> Step: Select One Fitting from Columns A & B**

**69-0A-10-4-14\***

Prefix Number    O<sub>2</sub> Hose    Length    Fitting #1    Fitting #2

Use "A" in Anesthesia (color coded conductive) or Use "R" in Respiratory (clear nylon braid)

**\*Ordering Example**

**Special Assemblies Available upon request**

- Respiratory/Lab Use will be constructed from clear nylon braid hose.
- Anesthesia Use will be constructed from color coded conductive hose. (NFPA99)
- If desired an elbow (90°) can be included by adding the suffix "L" after the desired fitting.
- If desired a pivoting swiveling elbow (90°) can be included by adding the suffix "P" after the desired fittings.
- For MRI conditional fittings add the suffix "M" after the desired fitting (not available for all fittings). (Please allow additional delivery time on MRI hoses.)

**Important WAGD**

Because WAGD is the newer form of waste gas disposal and was used before a compressed gas association standard (#2220) was established, the possibility exists that this hose can be constructed with different fittings. When ordering WAGD hoses, please specify whether fitting A or B are utilizing vacuum or WAGD standards.

**Important Industry Update:**  
NITROGEN: Fitting #3 and #10

For years Schrader adapters and check units were not manufactured with nitrogen-specific indexing. In 2004 Schrader released such fittings which are now recommended for all nitrogen-driven products in place of the medical air version adopted by the industry for decades. Please use care when ordering.

**NOTE: Assemblies are custom built to your specifications and, therefore, are not returnable. Thank you for understanding.**

**Use care when ordering using manufacturer name on gas outlets, as manufacturer name is not indicative of a specific type of fitting.**

**NOTE: Certain end fittings may not be available, depending on gas service selected.**

# Hoses/Assemblies (Low Pressure)

## BULK HOSE ONLY\*\*

**Per Foot (Also available on convenient spools)**

- 69-10006** Yellow conductive for medical air; 1/4" I.D.
- 69-10007** Blue conductive for nitrous; 1/4" I.D.
- 69-10008** Green conductive for oxygen; 1/4" I.D.
- 69-10009** White conductive for vacuum; 1/4" I.D.
- 69-10010** Clear nylon braid non-conductive; 1/4" I.D.
- 69-10022** Black conductive for nitrogen; 1/4" I.D.
- 69-10023** Lavender conductive for WAGD; 1/4" I.D.
- 69-10026** Gray conductive for carbon dioxide; 1/4" I.D.
- 69-20253\*\*** Ferrules to fit above hose. 10/pk (except 69-10027)
- 69-21128** Hose cutting device
- 69-21129** Replacement blade
- 69-10027** White conductive for vacuum; 5/16" I.D.  
(use 69-20665 ferrules 10/pk)
- 69-10028** White, non-conductive for vacuum; 1/4" I.D., I.D. for non-hazardous environments
- 69-10031** Clear nylon braid non-conductive; 5/16" I.D.
- 69-10030** Lavender, non-conductive; 5/16" I.D.
- 69-10034** Red, conductive for instrument air; 1/4" I.D.



### Up to 200 PSI

Conductivity is achieved by adding carbon black to inner core in the manufacturing process. Conductivity meets NFPA 99 requirements.

Certified FDA MEDICAL GRADE PVC compound. Bio-compatible as tubing circuits for biomedical, hospital and laboratory apparatus where crystal clear, flexible PVC tubing is used. Not for use in surgical procedures where direct contact with body fluids, tissues and parenteral solutions is required. Clean, not sterile, not conductive.

Color designation for specific gases, refer to U.S. Standards; ISO Standards, designate different colors for certain gases (White = Oxygen; Yellow = Vacuum Black/White = Medical air).

## COILED HOSES

Maxtec® offers the unique oxygen and air self-coiling hoses. They are made of a high-grade polyurethane material to help keep the work-space clean and tidy. Available in both single and dual coils with D.I.S.S. fittings only.

- 15' Dual Coil Ventilator Hose #HO-R129P02
- 10' Dual Coil Blender Hose #HO-R129P01
- 15' Single Coil Oxygen Hose #HO-R127P35
- 15' Single Coil Air Hose #HO-R128P34

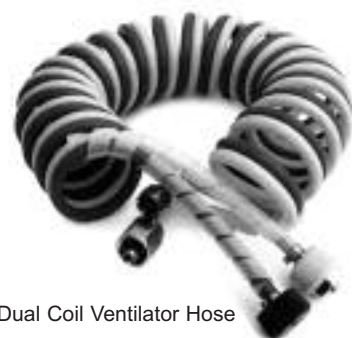

15' Dual Coil Ventilator Hose



15' Single Coil Oxygen Hose



15' Single Coil Air Hose

## HOSPITAL MEDICAL GRADE VINYL TUBING

With superior Optical Clarity and Micro-Smooth Bore meets U.S. Pharmacopeia Class VI Criteria.

Tubing is non-toxic, non-reactive, odorless and tasteless. It can be sterilized with steam (20 PSI for 15 minutes) or chemical bactericide or gas (ethylene oxide).

ITEM NO.	I.D.	O.D.	WALL	MAX. Working Pressure	Coil Length	Std. Order Quantity
<b>69-40001</b>	1/8"	1/4"	1/16"	59	100'	1 Coil
<b>69-40002</b>	3/16"	5/16"	1/16"	51	100'	1 Coil
<b>69-40003</b>	1/4"	3/8"	1/16"	51	100'	1 Coil
<b>69-40004</b>	1/4"	7/16"	3/32"	Suction	100'	1 Coil
<b>69-40005</b>	5/16"	7/16"	1/16"	50	100'	1 Coil
<b>69-40006</b>	3/8"	1/2"	1/16"	40	100'	1 Coil
<b>69-40007</b>	1/2"	5/8"	1/16"	28	100'	1 Coil
<b>69-40008</b>	3/8"	9/16"	3/32"	50	100'	1 Coil



# Hoses/Assemblies (Low Pressure)

## BIRD TYPE HOSES

- #09-9448 3' Oxygen hose D.I.S.S. female x D.I.S.S. female (Blender to ventilator)
- #09-9520 2' Oxygen hose D.I.S.S. female x D.I.S.S. female (Blender to ventilator)
- #09-3911 6' Medical air hose D.I.S.S. female x D.I.S.S. female (Blender)
- #09-3867 3' Medical air hose D.I.S.S. female x D.I.S.S. female (Blender and 6500 Compressor)
- #09-3868 3' Oxygen hose D.I.S.S. female X D.I.S.S. male (Blender)
- #09-0060 15' Oxygen hose D.I.S.S. female x D.I.S.S. male (Mark Units & Blender Inlet)
- #09-0067 1.5' Oxygen hose D.I.S.S. female x D.I.S.S. male (Blender inlet)
- #09-0938 9' Oxygen hose D.I.S.S. female x D.I.S.S. male (Blender inlet)
- #09-1256 4' Oxygen hose D.I.S.S. female x D.I.S.S. male (Blender inlet)
- #09-2899 15' Medical air Hose D.I.S.S. female x D.I.S.S. female (Blenders)
- #09-5121 15' Nitrous Oxide hose D.I.S.S. female X D.I.S.S. female (Blenders)
- #09-15440 6' Oxygen hose D.I.S.S. female x D.I.S.S. female (Blender to Avian Ventilator)
- #09-10293 6' Oxygen hose D.I.S.S. female X D.I.S.S. female (Avian Supply Hose)



Oxygen Pressure Hose  
male/female threaded connector (9/16"-18)

## NELLCOR PURITAN - BENNETT TYPE HOSES

- #06-018793 High pressure hose, D.I.S.S. medical air, male x D.I.S.S. medical air female, 10 ft. (3.05m)
- #06-018794 Medical air Hose, D.I.S.S. medical air female x D.I.S.S. medical air female, 27" (0.69 m)



Nitrous Oxide/Medical air Pressure Hose  
female/female threaded connector (3/4"-16)

## D.I.S.S. OXYGEN FEMALE X D.I.S.S. OXYGEN FEMALE

- #06-001474 10' Length, non-conductive
- #06-006539 6' Length, non-conductive
- #06-006543 3.5' Length, non-conductive

## D.I.S.S. MEDICAL AIR FEMALE X D.I.S.S. MEDICAL AIR FEMALE

- #06-006540 6' Length Non-Conductive
- #06-006541 10' Length Non-Conductive

## D.I.S.S. OXYGEN MALE X D.I.S.S. OXYGEN FEMALE

- #06-007834 10' Length Non-Conductive

## SECHRIST TYPE HOSES

- #71-IV-308 14' Length, Medical air, D.I.S.S. female x D.I.S.S. female, non-conductive
- #71-IV-309 14' Length, Oxygen, D.I.S.S. male x D.I.S.S. female, non-conductive

## BEAR TYPE HOSES

- #91-50000-01000 Medical air hose, 12' length D.I.S.S. female x D.I.S.S. female
- #91-50000-01001 Oxygen hose, 12' length, D.I.S.S. female x D.I.S.S. female

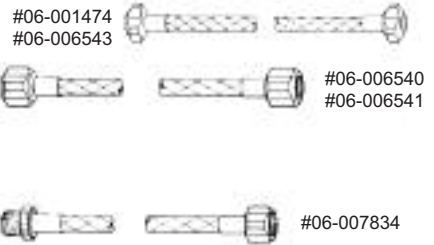

## SELF-STORING AIR HOSE



Extruded from heavy duty nylon. Retracts to coil 1/30th of maximum length. Oil and moisture resistant at 200 PSI maximum working pressure. Reusable 1/4-18 male fitting on one end, swivel fitting on other end, each with coil spring guard. Fittings terminate in 1/4 - 1/8 male thread. Not for use with oxygen.

- #69-208-90 12' hose (9' usable length)
- #69-207-46 25' hose (18' usable length)

## HEAVY-DUTY JET BLOWGUNS



Positive lever-control for full - range medical air delivery. Self-cleaning, leakproof, rustproof stainless steel one-piece valve. Hanging hook is integral part of gun. Meets requirements of Par. 1910.242(b) of the Occupational Safety & Health Act; max. pressure with nozzle blocked off 25 PSI at 100 PSI inlet. Terminates in 1/4 - 18 female thread. Fits self storing air hose.

- #69-208-89 Compressed Air Gun

## INFRASONICS TYPE HOSES

- #FI-4401005 Medical air hose, 12' length, D.I.S.S. female handnut x D.I.S.S. female handnut
- #FI-4401004 O2 hose, 12' length, D.I.S.S. female handnut x D.I.S.S. female handnut

## Hamilton Medical Type

- #CO-52010 Oxygen Hose Assy
- #CO-52020 Medical Air Hose Assy
- #CO-52021 Medical Air Hose Assy for compressor 3' length



#69-206-14  
Hose Retractor  
18" Length

# Hose Ferrules/Tools

#69-206-60	Hose Ferrule, .330" I.D., 1/2" long	10 /pkg
#69-206-61	Hose Ferrule, .358" I.D., 1/2" long	10 /pkg
#69-206-62	Hose Ferrule, .380" I.D., 1/2" long	10 /pkg
#69-206-63	Hose Ferrule, .478" I.D., 11/16" long	10 /pkg
#69-202-51	Hose Ferrule, .410" I.D., 1/2" long	10 /pkg
#69-202-52	Hose Ferrule, .450" I.D., 9/16" long	10 /pkg
#69-202-53**	Hose Ferrule, .500" I.D., 1/2" long	10 /pkg
#69-202-54	Hose Ferrule, .525" I.D., 1/2" long	10 /pkg
#69-202-55	Hose Ferrule, .548" I.D., 31/64" long	10 /pkg
#69-206-64	Hose Ferrule, .564" I.D., 3/4" long	10 /pkg
#69-206-65	Hose Ferrule, .575" I.D., 31/64" long	10 /pkg



### #69-203-41

Portable Vise Grip Hand tool for 3/16" I.D. 1/4" I.D. hose. Ideal for quick assembly and field repairs. For .478 to .575 I.D. ferrules.



### #69-208-77

Portable Vise Grip Hand tool for .330 I.D. to .450 I.D. ferrules.



### #69-206-66

Heavy Duty Ferrule Machine  
Designed for high volume hose assembly production. Contracting die sets sold separately.



### #69-208-78

Bench Model Crimper with (5) sets of integral dies for crimping hoses of various sizes. Designed to be bench mounted for maximum leverage and crimping ease.

### #69-206-67

Contracting Die Sets  
Ribbed Die Set to crimp 1/4" I.D. hose.\*\*



\*\* For Bulk Hose except #69-10027, 69-10030, 69-10031.





## Series Magnehelic® Differential Pressure Gauges 2000

Indicate low medical air or gas pressures-- positive, negative or differential. Accurate within 2%. 81 Ranges



Standard Magnehelic Pressure Gauge has large easy- to-read 4" dial.

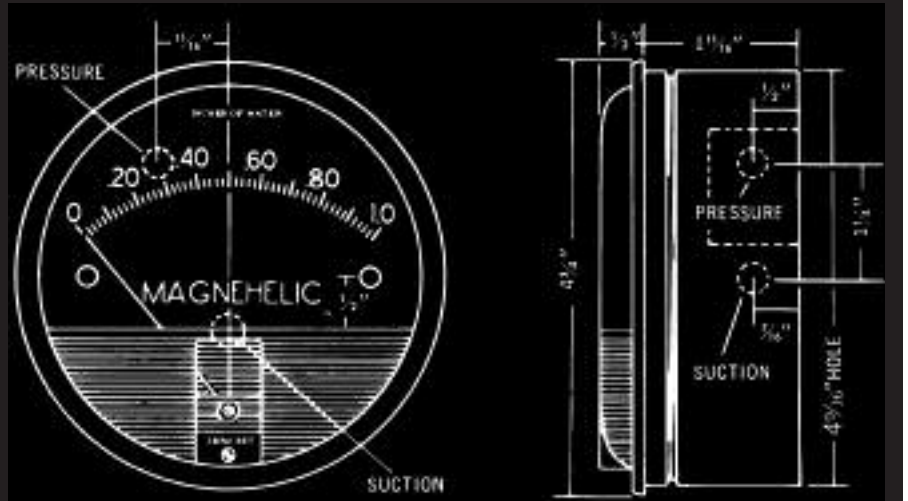

Dimensions Standard Series 2000 Magnehelic® Pressure Gauges  
(Slightly different on medium and high pressure models)

Select the Dwyer Magnehelic® gauge for high accuracy - guaranteed within 2% of full scale - and for the wide choice of 81 ranges available to suit your needs precisely. Using Dwyer's simple, frictionless Magnehelic® movement, it quickly indicates low medical air or non-corrosive gas pressures - either positive, negative (vacuum) or differential. The design resists shock, vibration and over-pressures. No manometer fluid to evaporate, freeze or cause toxic or leveling problems. It's inexpensive, too.

Widely used to measure fan and blower pressures, filter resistance medical air velocity, furnace draft, pressure drop across orifice plates, liquid levels with bubbler systems and pressures in fluid amplifier or fluidic systems. It also checks gas-medical air ratio controls, and automatic valves, and monitors blood and respiratory pressures in medical care equipment.

Mounting. A single case size is used for most ranges of Magnehelic gauges. They can be flush or surface mounted with standard hardware supplied. With the optional FR-A-610 Pipe Mounting Kit they may be conveniently installed on horizontal or vertical 1-1/4" - 2" pipe. Although calibrated for vertical position many ranges above 1 inch may be used at any angle by simply re-zeroing. However, for maximum accuracy, they must be calibrated in the same position in which they are used. These characteristics make Magnehelic gauges ideal for both stationary and portable applications. A 4-9/16" hole is required for flush panel mounting. Complete mounting and connection fittings plus instructions are furnished with each instrument.



### PHYSICAL DATA

- Ambient temperature range:** 20° to 140°F\*
- Rated total pressure** - 20N Hg. to 15 psig.\*\*
- Over Pressure:** Relief plug opens at approximately 25psig.
- Connections:** 1/8" NPT female high and low pressure taps duplicated - one pair side and one pair back.
- Housing:** Die cast aluminum case and bezel, with acrylic cover. Exterior finish is coated gray to withstand 168 hour salt spray corrosion test.
- Accuracy:** ±2% of full scale (3% on - 0 and 4% on - 00 ranges), throughout range at 70°F.
- Standard Accessories:** Two 1/8" NPT plugs or duplicate pressure taps, two 1/8" pipe thread to rubber tubing adapters, and three flush mounting adapters with screws. (Mounting ring and snap ring retainer substituted for 3 adapters in MP and HP gauge accessories.)
- Weight:** 1lb., 2 oz.

\* Low temperature models available as a special option.

\*\* For applications with high cycle rate within gauge total pressure rating next higher rating is recommended.

Model Number	Range CM of Water
#FR-2000-15CM	0-15
#FR-2000-20CM	0-20
#FR-2000-25CM	0-25
#FR-2000-50CM	0-50
#FR-2000-80CM	0-80
#FR-2000-100CM	0-100
#FR-2000-150CM	0-150
#FR-2000-200CM	0-200
#FR-2000-250CM	0-250
#FR-2000-300CM	0-300
Zero Center Ranges	
#FR-2300-4CM	2-0-2
#FR-2300-10CM	5-0-5
#FR-2300-30CM	15-0-15
**These ranges calibrated for total vertical scale position.	

## Back Mount



**Vacuum Gauges**  
#69-20028

Vacuum Contents - 1 1/2" Dial - 0-30 in. Hg - 1/8" NPT back mount



#69-20025  
#69-20027  
#69-20013

## Pressure Gauges

Pressure 0-60 PSI-1 1/2" dial - 1/8" NPT (Non Hazardous gases)  
Pressure 0-100 PSI - 1 1/2" dial - 1/8" NPT (Non Hazardous gases)  
Nitrogen (0-300 PSI) 1 1/2" dial - 1/8" NPT (typically used on regulators powered by Nitrogen for power tools)

**AIRWAY PRESSURE GAUGE\***  
**REPLACEMENT PARTS #06-130089**



#06-616155

Adapter-Polysulfone (Plastic)

\*Do not autoclave, gas-vacuum sterilize only.

## Zone Valve Gauges



#32-77-90-0571

0-100 PSI-1 1/2" dial - 1/8" NPT male-back mount for use with oxygen, nitrous oxide, and medical air

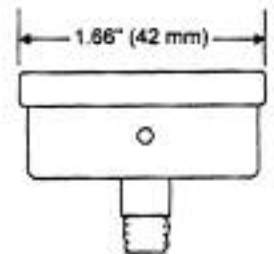

#32-77-90-0572

0-30" Hg-1 1/2" dial - 1/8" NPT male back mount for use with vacuum



#32-77-90-0573

0-300 PSI - 1 1/2" dial - 1/8" NPT male - back mount for use with nitrogen



#69-20020

## Nitrogen Gauges

Nitrogen Bottom Mount (0-300PSI) 1-1/2" dial - 1/8" NPT



#69-20007  
#69-20008  
#69-20009  
#69-20010  
#69-20032

## 0-100 PSI Gauges

Oxygen - 1-1/2" dial - 1/8" NPT - Green Face  
Oxygen - 2" dial - 1/4" NPT - Green Face  
All gases - 2" dial - 1/4" NPT - White Face (non-hazardous gases)  
Nitrous Oxide - 2" dial - 1/4" NPT - Blue Face  
All gases - 1-1/2" dial - 1/8" NPT - White Face (non-hazardous gases)

#69-20055  
#69-20056

Oxygen - 2" dial - 1/8" NPT  
All Gases - 2" dial - 1/8" NPT (Non-Hazardous Gases) Plastic Case



## Miscellaneous Gauges (Bottom Mount - White Face) (non-hazardous gases)

#69-20033  
#69-20014  
#69-20015  
#69-20016  
#69-20017  
#69-20018  
#69-20019

All gases pressure gauge - 2" dial - 0-15	PSI - 1/4" NPT
All gases pressure gauge - 2" dial - 0-30	PSI - 1/4" NPT
All gases pressure gauge - 2" dial - 0-60	PSI - 1/4" NPT
All gases pressure gauge - 2" dial - 0-200	PSI - 1/4" NPT
All gases pressure gauge - 2" dial - 0-400	PSI - 1/4" NPT
All gases pressure gauge - 2" dial - 0-600	PSI - 1/4" NPT
All gases pressure gauge - 2" dial - 0-1000	PSI - 1/4" NPT



#25-0550-0223

## Dual Range Gauges

Pressure/Vacuum - 0-200 PSI and 0-30" Hg Vacuum 2" Dial 1/4" NPT Bottom Mount (Note: 150PSI ILLUSTRATED)



#69-20035

## Vacuum Gauges

Vacuum contents - 2" dial, 0-30 in. Hg - 1/4" NPT bottom mount, black casing



#57-3-101  
#57-3-102

## Replacement Suction Gauges for W.T. Farley® DU-O-VAC and OEM Medical (C.I.G.) Twin-O-VAC

0-600mmHg Suction Gauge, Bottom Mount 1/4 NPT Male  
0-200mmHg Suction Gauge, Bottom Mount 1/4 NPT Male

# Gauges

## Cylinder Contents 0 - 3000 PSI Minimum Bottom Mount



#69-20000  
#69-20001  
#69-20002  
#69-20003  
#69-20004  
#69-20050  
#69-20051

Oxygen contents - 1-1/2" dial - 1/8" NPT  
Oxygen contents - 2" dial - 1/4" NPT  
All gases contents - 2" dial - 1/4" NPT (non-hazardous gases)  
All gases contents - 1-1/2" dial - 1/8" NPT (non-hazardous gases)  
Nitrous Oxide contents - 2" dial - 1/4" NPT - Blue Face  
Oxygen contents - 2" dial - 1/8" NPT  
All gases contents - 2" dial - 1/8" NPT

## Back Mount



#69-20012

Oxygen contents - 1-1/2" dial - 1/8" NPT, male thread

## Back Mount Slim Line



#69-20058

Oxygen contents - 1-1/2" dial - 1/8" NPT male thread  
(Looks similar to many fire extinguisher gauges)

## Back Mount Slim Line with Protective Boot



#69-20049

Oxygen contents - 1-1/2" dial - 1/8" NPT male thread. Supplied with protective boot.

## Gauges For Mada® & Erie® Regulators



#69-20042  
#69-20043

Oxygen, 1-1/2" Diameter, 4,000 PSI, 1/8" NPT Male Bottom Port  
Oxygen, 1-1/2" Diameter, 4,000 PSI, 1/8" NPT Male Back Port



Front

#69-20059

Oxygen contents tank gauge with low pressure alarm when tank pressure falls below 500 PSI Audible & Visual Indicators. Gauge size 2". 1/8" NPT male bottom port.

## NEW



#69-20060

Oxygen contents tank gauge with low pressure alarm when tank pressure falls below 500 PSI. Audible and visual indicators. 1/4" NPT male bottom port. Gauge size 2".

#69-20061

Nitrogen contents tank gauge with low pressure alarm when tank pressure falls below 500 PSI. Audible and visual indicators. 1/4" NPT male bottom port. Gauge size 2".

## LITER FLOW - BOTTOM MOUNT

(Always inspect orifice for correct size and verify gas delivery for accuracy upon completion of gauge replacement)



### 1/32 to 1/2 Liter Gauges

#69-20026 Oxygen flow - special orifice - 2" dial - 1/4" NPT



### 0-1 Liter Gauges

#69-20047 Oxygen Flow - 2" dial - 1/4" NPT



### 0-5 Liter Gauges

#69-20023 Oxygen flow - .26mm orifice - 2" dial - 1/4" NPT  
#69-20030 Oxygen flow - .26mm orifice - 1-1/2" dial - 1/8" NPT  
#69-20052 Oxygen flow - 2" dial - 1/8" NPT



### Replacement Gauges for MADA® & ERIE® Regulators

#69-20036 Oxygen flow - #77 orifice 1-1/2" dial - 1/8" NPT



### 0-8 Liter Gauges

#69-20021 Oxygen flow - #80 orifice - 1-1/2" dial - 1/8" NPT  
#69-20022 Oxygen flow - #80 orifice - 2" dial - 1/4" NPT  
#69-20053 Oxygen flow - 2" dial - 1/8" NPT



### Replacement Gauges for MADA® & ERIE® Regulators

#69-20038 Oxygen flow - #R orifice 1-1/2" dial - 1/8" NPT



### 0-15 Liter Gauges

#69-20005 Oxygen flow - #77 orifice - 1-1/2" dial - 1/8" NPT  
#69-20006 Oxygen flow - #77 orifice - 2" dial - 1/4" NPT  
#69-20054 Oxygen flow - #77 orifice - 2" dial - 1/8" NPT  
#69-20034 Oxygen flow - #73 orifice, 1-1/2" dial, 1/8" NPT



### Replacement Gauges for MADA® & ERIE® Regulators

#69-20040 Oxygen flow - #K orifice - 1-1/2" dial - 1/8" NPT

## LITER FLOW - BACK MOUNT

Item Not  
Shown

### 0 to 1/2 Liter Gauges

#69-20057 Oxygen Flow - 1-1/2" dial - 1/8"NPT

Item Not  
Shown

### 0 to 1 Liter Gauges

#69-20048 Oxygen flow - 1-1/2" dial - 1/8" NPT



### 0 to 5 Liter Gauges

#69-20029 Oxygen flow 1-1/2" dial - .26mm orifice - 1/8" NPT



### Replacement Gauges For MADA® & ERIE® Regulators

#69-20037 Oxygen flow 1-1/2" dial - 1/8" NPT (0 - 5 LPM)



### 0-8 Liter Gauges

#69-20024 Oxygen flow - 1-1/2" dial - #80 orifice - 1/8" NPT



### Replacement Gauges For MADA® & ERIE® Regulators

(0 - 8 LPM)

#69-20039 Oxygen flow - 1-1/2" dial - #R Orifice - 1/8" NPT



### 0-15 Liter Gauges





#69-20011 Oxygen flow - 1-1/2" dial - #77 orifice - 1/8" NPT



### Replacement Gauges For MADA® & ERIE® Regulators

(0 - 15 LPM)

#69-20041 Oxygen flow - 1-1/2" dial - #K orifice - 1/8" NPT

LITER RANGE ORIFICE SIZE	 STRAIGHT D.I.S.S. x 1/8	 STRAIGHT D.I.S.S. x 1/4	 3/16" 90° BARB x NPT		 3/16" STRAIGHT BARB x 1/8
1/2 LPM		#69-21008	1/8 NPT	1/4 NPT	
1LPM		#69-21010			
5LPM - .26MM	#69-21017	#69-21007	#69-21013	#69-21009	#69-21011
8LPM - #80	#69-21002	#69-21005	#69-21014	#69-21016	#69-21012
15LPM - #77	#69-21001	#69-21004	#69-21015		#69-21006
15LPM - #73		#69-21003			

# Gauges



#41-1101078P  
 Manometer - 20cmH<sub>2</sub>O to + 80cmH<sub>2</sub>O  
 Replacement for Drager Absorber System and Bain circuit modules.  
 Rear inlet 1/4-18 NPT male thread.



#41-1101078L  
 Replacement lens and bezel for the above.



#02-1400-8009-000  
 Manometer - 20cmH<sub>2</sub>O to + 100cmH<sub>2</sub>O  
 Replacement for Datex-Ohmeda GMS Absorber with 45° quick connect fitting. MRI compatible. Black casing.

#02-1400-8015-000  
 Same as above, but with straight quick connect fitting.



#41-4105853A  
 Manometer - 20cmH<sub>2</sub>O to 80cm H<sub>2</sub>O  
 with 45° elbow (not shown) for Drager Absorber system.

## REPLACEMENT LEXAN<sup>®</sup> GAUGE COVERS



#69-20741	Lens - for 1-1/2" gauge - snap on or screw type
#69-20742	Lens - for 2" gauge - snap on or screw type
#69-20743	Lens - for 1-1/2" gauge - snap in type for black case gauges
#69-21464	Lens - for 1-1/2" gauge snap in type for chrome case gauges

Helpful Hint ...

**Still not sure which gauge?** If the face of the gauge measures from 2" to 2-1/2" the thread fitting is usually 1/4" NPT male. If the face of the gauge measures from 1" to 1-1/2", the thread fitting is usually 1/8" NPT male.

\*Typically thread hint does not apply.

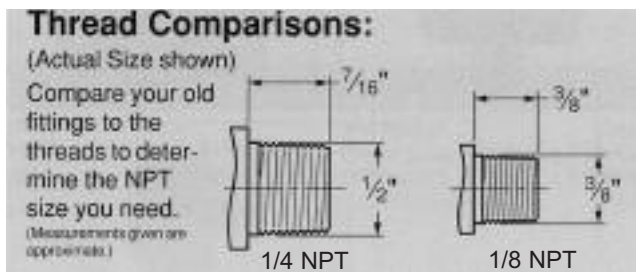

**Thread Comparisons:**  
 Compare your old fittings to the threads to determine the NPT size you need.  
 (Measurements given are approximate.)

# Gauges/Inspiratory Force



#GZ-NS60-TBR  
Negative Inspiratory Force Monitor includes adapter #GZ-BE149-1 and recording needle reads  $\pm 60\text{cm H}_2\text{O}$  in 2cm dial markings with 1/4" NPT connection on bottom.



#GZ-NS120-TRR  
Negative Inspiratory Force Monitor includes adapter #GZ-BE149-1 and recording needle reads  $\pm 120\text{cm H}_2\text{O}$  in 4cm dial markings with 1/4" NPT connection in rear.



#GZ-NS30-TRR  
Negative Inspiratory Force Monitor includes adapter #GZ-BE149-1 and recording needle reads  $\pm 30\text{cm H}_2\text{O}$  in 1cm dial markings with 1/4" NPT connection in rear.



#GZ-NS60-TRR  
Negative Inspiratory Force Monitor includes adapter #GZ-BE149-1 and recording needle reads  $\pm 60\text{cm H}_2\text{O}$  in 2cm dial markings with 1/4" NPT connection in rear.



#GZ-NS30-PBR  
Negative Inspiratory Force Monitor includes adapter #GZ-BE148-6 and recording needle reads  $\pm 30\text{cm H}_2\text{O}$  in 1cm dial markings with 1/8" small bore tubing connection on bottom.



#GZ-NS60-PBR  
Negative Inspiratory Force Monitor includes adapter #GZ-BE148-6 and recording needle reads  $\pm 60\text{cm H}_2\text{O}$  in 2cm dial markings with 1/8" small bore tubing connection on bottom.



#GZ-BE1481



#GZ-BE1486

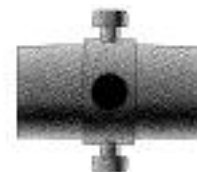

#GZ-BE1491

## Gauge Adapters

#GZ-BE1481  
with 1/4" NPT and 1/8" small bore tube adapter. For easy spot check of line pressure on ventilator or other pressure breathing devices. Use with any 1/4" NPT pressure gauge.

#GZ-BE1486  
with 1/8" tubing adapter and 22mm O.D./15mm I.D. end for remote inspiratory pressure monitoring.

#GZ-BE1491  
with 22mm O.D./15mm I.D. and 1/4" NPT. Attach to #GZ-BE149 pressure gauge and endo tube, trach tube or mask for inspiratory pressure monitoring.

#58-395946

- Respiratory force measuring device
- 60-0-60mmHg gauge with tubing, T-piece and 2 one-way valves
- Neoprene valve flaps
- Single use

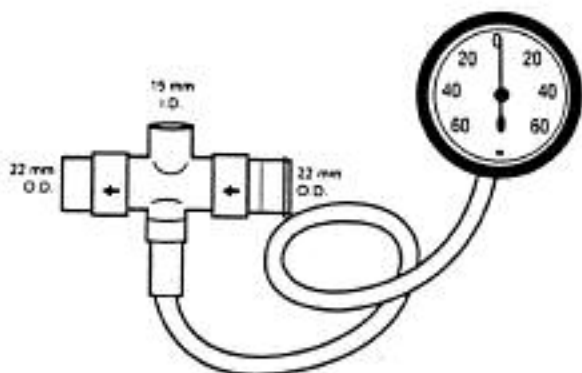

## Replacement Parts:

#58-395943  
• Gauge only, 60-0-60mmHg  
• Single use

#58-396072  
• Gauge only, positive pressure 0-25cm H<sub>2</sub>O  
• Single use



# Gauges/Patient Pressure



#GZ-NS30-TRS  
Gauge reads  $\pm 30\text{cm H}_2\text{O}$   
in 1cm dial markings with 1/4" NPT connection in rear.



#GZ-NS60-TRS  
Gauge reads  $\pm 60\text{cm H}_2\text{O}$   
in 2cm dial markings with 1/4" NPT connection in rear.



#GZ-NS120-TRS  
Gauge reads  $\pm 120\text{cm H}_2\text{O}$   
in 4cm dial markings with 1/4" NPT connection in rear.



#GZ-NS60-PBS  
Gauge reads  $\pm 60\text{cm H}_2\text{O}$   
in 2cm dial markings with 1/8" small bore tubing connection on bottom..



#GZ-NS30-PBS  
Gauge reads  $\pm 30\text{cm H}_2\text{O}$   
in 1cm dial markings with 1/8" small bore tubing connection on bottom.



#GZ-NS60-TBS  
Gauge reads  $\pm 60\text{cm H}_2\text{O}$   
in 2cm dial markings with 1/4" NPT connection on bottom.



## CUFF PRESSURE GAUGE

- #04-660001 Cuff Pressure Gauge
- #04-660565 Cuff Pressure Gauge tubing

#19-00-150  
Gauge Guard (only)  
to fit #19-00-199

#19-00-199  
Manometer  
#19-00-199-MRI  
MRI Version



Manometer has range of  $-40$  to  $+80\text{cm H}_2\text{O}$  in a 2-1/2" diameter chrome-plated case with 1/4 male NPT bottom connection. Has front zero correcting screw.

## Gauges/suction

---



#32-22-95-0017  
0-300mmHg 2" Vacuum gauge for Chemetron Vacutron continuous, intermittent, combo, and Surgical Regulator.



#32-22-95-0041  
0-150mmHg 2" Vacuum gauge for Chemetron Pediatric Model Vacutron Suction Regulator.



#32-22-95-2003  
0-300mmHg 2" Vacuum gauge for Chemetron mini-Vacutron continuous, intermittent, surgical, and combo (intermittent/continuous) Suction Regulator.



#32-22-95-2023  
0 - 150 mmHg 2" Vacuum gauge for Chemetron mini-Vacutron Pediatric continuous and Pediatric continuous/intermittent Suction Regulator.



#32-22-95-2033  
0-100mmHg 2" Vacuum gauge for Chemetron mini-Vacutron Low Vacuum Regulator.



#32-22-95-2013  
0-760mmHg 2" Vacuum gauge for Chemetron mini-Vacutron High Vacuum Regulator.



#EC-1562  
0-200mmHg, with full range vacuum gauge for Precision Medical (PM) Intermittent/Continuous Model Suction Regulator.

#EC-502269  
0-150mmHg Vacuum gauge for Precision Medical (PM), Model #PM3400 Pediatric Suction Regulator. (Not Shown)

## Gauges/Suction

---

#34-MG-B76

0-200 mmHg Vacuum gauge 2-1/2" Diameter  
1/8-27 NPT male bottom mount for Western and Union  
Carbide Suction regulator



#34-MG-71

0-200 mmHg + Full Vacuum Gauge (style may vary)

1/8" - 27 NPT Male Bottom Mount, 2-1/2" Diameter  
for Western, Union Carbide Suction Regulator



#06-130096-PG

0 - 200 mmHg Vacuum Gauge  
1/4" - 18 NPT Male Bottom Mount,  
for Nellcor Puritan-Bennett Suction Regulator  
and Interrupter

# Gauges/Suction

---

#02-6700-0050-200

0-200 mmHg with full line range Vacuum gauge for Ohmeda standard two-mode continuous, standard three mode continuous, standard surgical/ free flow, posi-pulse and intermittent suction unit (ISU).  
Includes Lens



#02-6700-0050-201

0-760 mmHg Vacuum gauge for Ohmeda High continuous and High surgical free-flow suction regulator. Includes lens.

#02-6700-0050-202

0-180 mmHg Vacuum gauge for Ohmeda Low continuous suction regulator. Includes lens



#02-6700-0430-850

0-65 cm H<sub>2</sub>O Vacuum gauge for Ohmeda Thoracic suction regulator supplied without lens.



#02-6700-0087-500

Replacement lens all Ohmeda suction regulators

## Gauges/Suction

---

#21-598-D  
0-200mmHg Vacuum gauge  
1/4-18 NPT Male Bottom Mount for Oxequip Surgical Model  
Quadra-VAC Suction Regulator with HI-VAC (Full) range and  
Timeter model VR1000 Suction Regulator  
(Note: Does **NOT** include swivel assembly)



#21-598-B  
0-200mmHg Vacuum gauge  
1/4-18 NPT Male Bottom Mount  
for Oxequip Standard and Pediatric  
QUADRA-VAC Suction Regulator



#BB-9071  
0-200mmHg Vacuum gauge  
1/8-27 NPT Male Bottom Mount  
for Boehringer Labs Model 7700 Suction Regulator

# Gauges/Test

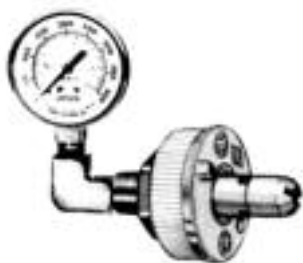

(Photo for reference only)  
Pressure Range 0-100 psi  
Vacuum Range 0-30 in Hg.



Liter Meter ranges from  
2.5, 8, 15LPM

## Flow Tester

- #BG-170MM3 1/4 - 2-1/2 LPM Range
- #34-MT 200 1/2 - 8 LPM Range
- #34-MT 300 2 - 15 LPM Range

Anodized Aluminum 1/4" Hose  
Barb Connector attaches to standard  
vacuum tubing



Digital Display - from 0 to 760 mmHg  
in 1 mmHg increments



**Requires no user interface!**  
Unit automatically activates when a  
vacuum source is detected.

## WITH OHMEDA (OHIO) DIAMOND INLET ADAPTER

- #69-219-00 Oxygen test gauge
- #69-219-01 Nitrous oxide test gauge
- #69-219-02 Medical air test gauge
- #69-219-03 Vacuum test gauge

## WITH CHEMETRON (NCG) INLET ADAPTER

- #69-219-04 Oxygen test gauge
- #69-219-05 Nitrous oxide test gauge
- #69-219-06 Medical air test gauge
- #69-219-07 Vacuum test gauge

## WITH SCHRADER INLET ADAPTER

- #69-219-08 Oxygen test gauge
- #69-219-09 Nitrous oxide test gauge
- #69-219-10 Medical air test gauge
- #69-219-11 Vacuum test gauge

## WITH PURITAN BENNETT INLET ADAPTER

- #69-219-12 Oxygen test gauge
- #69-219-13 Nitrous oxide test gauge
- #69-219-14 Medical air test gauge
- #69-219-15 Vacuum test gauge

## WITH OXEQUIP (OES) TWIST INLET ADAPTER

- #69-219-16 Oxygen test gauge
- #69-219-17 Nitrous oxide test gauge
- #69-219-18 Medical air test gauge
- #69-219-19 Vacuum test gauge

## WITH OXEQUIP MED\*STAR INLET ADAPTER

- #69-219-20 Oxygen test gauge
- #69-219-21 Nitrous oxide test gauge
- #69-219-22 Medical air test gauge
- #69-219-23 Vacuum test gauge

## WITH D.I.S.S. FEMALE INLET ADAPTER

- #69-219-24 Oxygen test gauge
- #69-219-25 Nitrous oxide test gauge
- #69-219-26 Medical air test gauge
- #69-219-27 Vacuum test gauge

## Part Number Description #EC-PM760 Digital Vac Check Unit

- Dimensions: Width: 1.63, Height: 2.13, Depth: 1.00
- Vacuum Range: 0-760 mmHg
- Accuracy: ± 1% over full scale range
- Connector: 1/4" hose barb
- Battery: Lithium Ion (8 to 10 year life)
- Weight: .15 lb.

## Gauges/Bird Type

---



#09-0145R Manometer - 10cm H<sub>2</sub>O to + 80cm H<sub>2</sub>O for Mark series, with mounting bracket, 6" - 1/8" ID tubing with orifice and two bracelet hose clamps. Rear inlet connection.

#69-20045 Replacement gauge only with mounting bracket.



#09-4407R Manometer - 10cm H<sub>2</sub>O to + 120cm H<sub>2</sub>O for Bird Mark ventilator and Mark 14 with mounting bracket tubing with orifice and two bracket hose clamps. Rear inlet connection.

#69-20046 Replacement gauge only with mounting bracket.



#09-9799 Manometer - 20cm H<sub>2</sub>O to + 140cm H<sub>2</sub>O for Bird 6400ST, 8400ST and VIP ventilator. 1/8"Rear inlet tubing connection.



#09-2631 Manometer -40cm H<sub>2</sub>O to + 40cm H<sub>2</sub>O Large 2-7/8" diameter dial with 3/8" bottom tubing connection.

#09-2632 Same as above with 3' tubing.



#09-0145A Replacement lens and bezel for 69-20046, 09-0145R, 69-20045, 09-4407R and 09-0902R Gauges.

## USED TO REDUCE PIPELINE PRESSURE TO WORKABLE PRESSURE



**#69-20516**  
Nitrogen Regulator assembly, Dynacon male to set screw lock for acceptance of a Medical Air Schrader male - 180°



**#69-20514**  
Nitrogen regulator assembly, D.I.S.S. Nitrogen female to set screw lock for acceptance of a Medical Air Schrader male - 180°



**#69-20351**  
Nitrogen regulator assembly, Dynacon male to Schrader Nitrogen check valve - 180°  
*(for the same configuration with Medical Air Schrader use #69-21700)*



**#69-20749**  
Nitrogen regulator assembly, D.I.S.S. Nitrogen female inlet to D.I.S.S. Nitrogen male outlet - 90°

**#69-21241**  
Nitrogen Regulator assembly, D.I.S.S. Nitrogen female inlet to Schrader Nitrogen check valve - 180°  
*(for the same configuration with Medical Air Schrader use #69-21701)*

**#69-21242**  
Nitrogen regulator assembly, D.I.S.S. Nitrogen female inlet to Schrader Nitrogen check valve - 90°  
*(for the same configuration with Medical Air Schrader use #69-21702)*

Nitrogen Regulator assembly, 90° Dynacon male to set screw lock for acceptance of a Medical Air Schrader male



Nitrogen regulator assembly, 90° D.I.S.S. Nitrogen female to set screw lock for acceptance of a Medical Air Schrader male



Nitrogen regulator assembly, 90° Dynacon male to Schrader Nitrogen check valve  
*(for the same configuration with Medical Air Schrader use #69-21703)*



Nitrogen regulator assembly, D.I.S.S. Nitrogen female inlet to D.I.S.S. Nitrogen male outlet - 180°



Nitrogen Regulator assembly, Schrader Nitrogen male inlet to Schrader Nitrogen check valve - 180°  
*(for the same configuration with Medical Air Schrader inlet male and outlet female use #69-21704)*



Nitrogen regulator assembly with 1/4" NPT female inlet and outlet.



**NOTE: All of the regulators listed above are designed to carry Nitrogen Gas at pressures not to exceed 180 psi. Some of these regulators are equipped with a Schrader fitting. These female couplers could be for Nitrogen or Medical Air, since both have been used by saw and drill manufacturers. Please "USE CAUTION" when connecting hoses to ensure proper connection and application.**



# Electrical Supplies/PowerMATE®-IsoMATE®

## PowerMATE®/PowerMATE® 20 amp\* *(Bold bulleted items refer to PowerMATE 20 amp)*

The PowerMATE®/PowerMATE® 20 amp is the only IV pole mountable power tap UL approved for use in patient care areas. UL Recognized Component to UL 1363A.

### Features:

- Cord management
- Safe and convenient access to additional outlets
- Increased equipment mobility with 15 ft power cord
- Drip guard protection
- Locks to an IV pole or cart leg
- Patent Pending
- 15 ft, hospital grade power cord - 14 gauge, US NEMA 5-15P molded plug (Gray color);  
\***US NEMA 5-20P molded plug (Black color)**
- Hospital grade receptacles - US NEMA 5-15R; 2 pole, 3 wire grounding (Gray color);  
\***US NEMA 5-20R; 2 pole, 3 wire grounding (Gray color)**
- Circuit Breaker rating - 15 amps, 125 volts/\***20 amps, 125 AC volts**

### Specifications:

Output	120V, 50-60Hz, 12Amp/* <b>120V, 15Amp</b>
Cord Length	15' Hospital Grade/* <b>15' Hospital Grade</b>
Plug	5-15P Hospital Grade
Receptacles	3 Duplex Hospital Grade
Power ON Indicator	Green Lamp Indicator
Mounting Pole Diameter	0.875" to 1.5"/* <b>0.875" to 1.5"</b>
Operating Environment	0 to 50°C, 0 to 95% RH
Storage Environment	-20 to 65°C, 0 to 95% RH
Weight	3.02 lbs. MAX/* <b>4 lbs.</b>
Approximate Dimensions	5.28" wide, 3.27" deep, 5.65" high/* <b>5.28" wide, 3.27" deep, 5.45" high</b>
Regulatory Approvals	UL recognized component to UL1363A
Warranty	1 Year
Annual Maintenance	<ul style="list-style-type: none"> <li>• Inspect for mechanical damage</li> <li>• Check lamp indicator and outlet function</li> <li>• Inspect safety labels for legibility</li> </ul>
Cleaning	Unplug power and surface clean with 70% alcohol solution
Disposal	Dispose per local regulations for non-hazardous material



#10-20025



**20 amp**  
#10-20026

**WARNING:** Connecting equipment that is NOT part of the medical system to the PowerMATE® increases the risk of electrical shock.

## IsoMATE®

The IsoMATE® contains a medical grade isolation transformer to limit patient leakage current to 100µA. Designed for use with electronic or electromedical devices in patient care areas, the IsoMATE® is a UL listed device to UL60601-1 and CSA C22.2 No. 601 US Patent Number 7,777,995.

### Features:

- Mounts to an IV pole with a diameter of 0.75" to 2.50"
- 15 ft, hospital grade power cord - 16 gauge, US NEMA 5-15P molded plug (Gray color)
- System Rating: 120V, 60Hz, 5 Amp
- Dimensions: 8" wide x 9" deep x 8" high
- Weight: 18 lbs
- 2 year warranty

### Specifications:

Output	120V, 60Hz, 5Amp
Cord Length	15' Hospital Grade
Plug	5-15P Hospital Grade
Receptacles	3 Duplex Hospital Grade - 5 Amp MAX
Power ON Indicator	Green Lamp Indicator
Mounting Pole Diameter	0.75" to 2.5"
Operating Environment	0 to 35°C, 0 to 95% RH
Storage Environment	-20 to 65°C, 0 to 95% RH
Weight	18 lbs. MAX
Approximate Dimensions	8" wide, 9" deep, 8" high
Regulatory Approvals	UL60601-1, CSA C22.2 No. 601
Warranty	2 Years
Annual Maintenance	<ul style="list-style-type: none"> <li>• Inspect for mechanical damage</li> <li>• Check lamp indicator and outlet function</li> <li>• Check transformer leakage current</li> <li>• Inspect safety labels for legibility</li> </ul>
Cleaning	Unplug power and surface clean with 70% alcohol solution



#10-20027

# Water Traps

Removes most solid liquid particles from compressed air. Filter element is 5 micron. Available in either manual or automatic drain. Supplied with D.I.S.S. medical air fittings except where noted.



Flow Direction

### Blender Application Configurations

- #69-50010 Manual drain type
- #69-50001 Automatic drain type

#69-50002  
Manual drain type

#69-50003  
Automatic drain type



Flow Direction

### Blank Traps

#69-50006 Manual Drain Type (1/8-27 female connections)



#69-50007 Automatic Drain Type (1/8-27 female connections)

#69-50008 Manual Drain Type (1/4-18 female connections)

#69-50009 Automatic Drain Type (1/4-18 female connections)

### Wall Or Ventilator Applications/Configurations

#### Ventilator Configurations (for application to inlet of ventilator)

- #69-50011 Manual Drain Type
- #69-50012 Automatic Drain Type



Flow Direction

- #69-50004 Manual Drain Type
- #69-50005 Automatic Drain Type



Flow Direction

#### Wall Configurations (for application on wall outlet)

- #69-50015 Manual Drain Type
- #69-50016 Automatic Drain Type



Flow Direction

- #69-50017 Manual Drain Type
- #69-50018 Automatic Drain Type



Flow Direction

### Repair Parts and Kits



- #69-50100 5 micron filter element
- #69-50101 Automatic drain only
- #69-50102 Manual drain valve
- #69-50103 Bowl w/automatic drain
- #69-50104 Bowl w/manual drain

**SPECIAL CONFIGURATIONS AVAILABLE WITH QUICK CONNECT FITTINGS**

# Miscellaneous



**#69-21103**  
Teflon Tape. Pipe thread sealant, 576" roll, 1/4" width.



**#69-21110**  
Vacuum Grease. Silicone lubricant for threads, O-rings, gaskets and seals in vacuum systems. 5.3 oz. tube.



**#69-21111**  
Detachol.™ Great for removal of stubborn adhesives. Safe for most surfaces. 4fl. oz.



**#69-21108**  
Thread Paste Compound 3-1/2 oz. tube.



**#69-21104**  
Heat Sink Compound



**#69-21101**  
Liquid Leak Detector. Pinpoints any gas leak as small as .0001cc per second. Safe for use with oxygen. 8 oz. bottle.



**#69-21105**  
Contact Cleaner 12 oz. can



**#69-21106**  
Spray Lubricant 11-12 oz. can (Brand may vary)



**#69-21102\***  
Service Removable Loctite 50cc bottle. (242)  
**#69-21127\***  
Red Loctite (271) 50cc Bottle  
\* NOTE: Not for use with oxygen.



**#69-21107**  
Freeze Spray Component Cooler 15 oz. can



**#BJ-3900**  
Oxygen Thread Repair (DIE)

# Miscellaneous

#09-0042

Lubricant on wick for  
Bird O-Ring Seals  
(Oxygen compatible)



#69-21113  
**Silver Goop**

Formulated for anti-seize on threaded parts of stainless steel and super alloys.

- Temperature to 1500°F (816°C) .
  - Non-melting.
  - Stays in place.
  - Will not drop off red hot surfaces.
  - Will not give off poisonous metal or oxide fumes at red heat.
  - Balanced composition keeps compound between mating surfaces to prevent seizing, regardless of force applied.
  - Lowers take-up torque on threaded parts, nuts, bolts and pipe threads.
  - Resist water washout.
  - Forms bond with surface to which it is applied.
  - Only occasional application needed after parts have been coated the first few times of use.
  - Not recommended for aluminum or magnesium.
- 1 oz. tube

#09-0631

Lubricant for Bird  
O-Ring Seals  
(Oxygen compatible)



#69-21112  
**High Purity Goop**

Anti-seizing compound for use on titanium, stainless steel, steel, aluminum and high-temperature alloys.

- Insert under conditions to 400°F (204°C).
  - Can be used when oily contamination may otherwise be a problem.
  - Non-corrosive to metals.
  - Impervious to moisture, high voltage and thermal cycling.
- 1 oz. tube

Item Not Shown

#09-3884

Vibratite  
30cc bottle used for various mounting screws and electronic trim pots for Bird ventilators. Great for other similar applications.

**FADE-A-DYNE™**

Removes Betadyne®\* and other iodine-based antiseptic stains from hospital environmental surfaces and fabrics. Just spray area and watch stains disappear.  
#0000-WHS101 16 oz. Spray Bottle

®\* Registered Trademark of the Purdue Frederick Co.



#69-21116

Krytox. Fluorinated Grease. Recommended by Puritan-Bennett Corp., as the lubricant of choice for Foregger Anesthesia Machines. 2 oz. Tube



#69-21115

Safety Solvent  
Used to remove residual lubricant from parts during cleaning procedures. 12 oz. Can

# Technical Information/Medical Gas Cylinders\*



CYLINDER	M2	M4	ML6	M6,B	M7	M9,C	D	JD	E	M60	M	H,T,K	LL
DIA./in.	2.5	3.2	4.3	3.2	4.3	4.3	4.3	5.3	4.3	7.3	8	9.3	21
HT./in. w/o valve	5.3	8.5	7.5	11.5	9	12	16.5	16.5	25.5	23	36	50-52	62-67

## Lightweight Aluminum Cylinders

Style	Oxygen Capacity ft <sup>3</sup>	Oxygen Capacity L	Weight No Valve, lb.	Service Pressure (psig)
M60	60	1699	22.5	2216
E	24	679	8	2015
M22	22.9	648	9	2216
M18	18	510	7.7	2216
D	15	425	5.5	2015
M9	8.7	246	3.9	2015
M7	7	198	3.5	2015
M6	5.8	164	2.4	2216
M4	4.0	113	1.8	2216

## Featherweight Composite Cylinders

Style	Oxygen Capacity ft <sup>3</sup>	Oxygen Capacity L	Weight No Valve, lb.	Service Pressure (psig)
M2IT	21.8	616	4.0	3000
M16T	16	453	2.9	2216
M06T	6.4	182	1.5	3000
M05T	5.7	160	1.4	3000
M04T	4.4	125	1.1	3000

Cylinder Size	Contents	Medical		Carbon		Nitrogen		Nitrous	
		Air	Dioxide	Helium	Oxygen	Oxide	Oxygen		
T	Cubic Feet (ft <sup>3</sup> )	311	638	291	304	637	337		
	Cubic Meters (m <sup>3</sup> )	8.62	17.68	8.07	8.42	17.66	9.34		
	Liters (L)	8,620	17,680	8,070	8,420	17,660	9,340		
	Gallons (gal)	2,277	4,671	2,132	2,225	4,666	2,468		
	Pounds (lb)	23.30	73.00	3.01	22.01	73.00	27.88		
	Kilograms (kg)	10.57	33.11	1.37	9.98	33.11	12.65		
J	Cubic Feet (ft <sup>3</sup> )	259	559	242	254	558	280		
	Cubic Meters (m <sup>3</sup> )	7.19	15.50	6.72	7.03	15.49	7.76		
	Liters (L)	7,190	15,500	6,720	7,030	15,490	7,760		
	Gallons (gal)	1,900	4,095	1,775	1,857	4,092	2,050		
	Pounds (lb)	19.44	64.00	2.51	18.38	64.00	23.16		
	Kilograms (kg)	8.82	29.03	1.14	8.34	29.03	10.51		
H	Cubic Feet (ft <sup>3</sup> )	233	559	218	229	558	249		
	Cubic Meters (m <sup>3</sup> )	6.46	15.50	6.04	6.34	15.49	6.90		
	Liters (L)	6,460	15,500	6,040	6,340	15,490	6,900		
	Gallons (gal)	1,707	4,095	1,596	1,675	4,092	1,823		
	Pounds (lb)	17.46	64.00	2.25	16.56	64.00	20.61		
	Kilograms (kg)	7.92	29.03	1.02	7.51	29.03	9.35		
G	Cubic Feet (ft <sup>3</sup> )	208	489	194	204	489	222		
	Cubic Meters (m <sup>3</sup> )	5.76	13.56	5.38	5.65	13.55	6.15		
	Liters (L)	5,760	13,560	5,380	5,650	13,550	6,150		
	Gallons (gal)	1,522	3,583	1,421	1,493	3,580	1,625		
	Pounds (lb)	15.55	56.00	2.01	14.76	56.00	18.36		
	Kilograms (kg)	7.05	25.40	0.91	6.70	25.40	8.33		
E	Cubic Feet (ft <sup>3</sup> )	23.5	56.2	22.0	23.0	56.2	24.9		
	Cubic Meters (m <sup>3</sup> )	0.65	1.56	0.61	0.64	1.56	0.69		
	Liters (L)	650	1,560	610	640	1,560	690		
	Gallons (gal)	172	412	161	169	412	182		
	Pounds (lb)	1.76	6.44	0.23	1.67	6.44	2.06		
	Kilograms (kg)	0.80	2.92	0.10	0.76	2.92	0.93		
D	Cubic Feet (ft <sup>3</sup> )	14.4	33.9	13.5	14.1	33.9	15.3		
	Cubic Meters (m <sup>3</sup> )	0.40	0.94	0.37	0.39	0.94	0.42		
	Liters (L)	400	940	370	390	940	420		
	Gallons (gal)	106	248	97.8	103	248	111		
	Pounds (lb)	1.08	3.88	0.14	1.02	3.88	1.27		
	Kilograms (kg)	0.49	1.76	0.06	0.46	1.76	0.58		

\*Figures indicated will vary depending on cylinder manufacturer and fill process from gas supplier.

# Technical Information

## Medical Gas Cylinder Valves - Threaded Connections

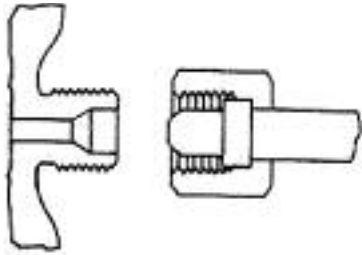

**CGA Connection No. 280**

.745-14NGO-RH-EXT

Carbon Dioxide-Oxygen Mixtures ( $\text{CO}_2 \leq 7.0\%$ )

Oxygen-Nitrogen Mixtures ( $\text{O}_2 > 23.5\%$ )

Helium-Oxygen Mixtures ( $\text{He} \leq 80\%$ )

Xenon-Oxygen Mixtures ( $\text{Xe} \leq 80\%$ )

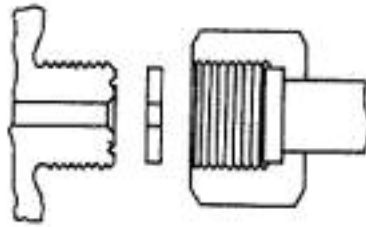

**CGA Connection No. 320**

.825-14NGO-RH-EXT

(Flat Nipple)

Carbon Dioxide

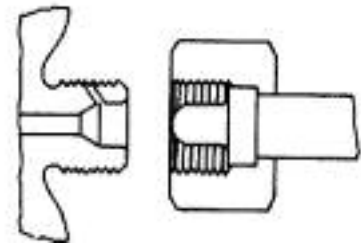

**CGA Connection No. 326**

.845-14NGO-RH-EXT

(Small Round Nipple)

Nitrous Oxide

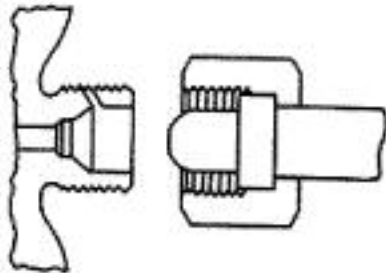

**CGA Connection No. 346**

(Formerly 1340)

.825-14NGO-RH-EXT

(Large Round Nipple)

Medical air

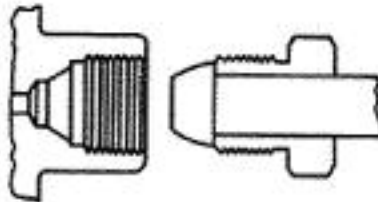

**CGA Connection No. 500**

.885-14NGO-RH-INT.

(Bullet Nipple)

Carbon Dioxide-Oxygen Mixtures

( $\text{CO}_2 > 7.0\%$ )

Helium-Oxygen Mixtures ( $\text{He} > 80.0\%$ )

Medical Device Gas Mixtures

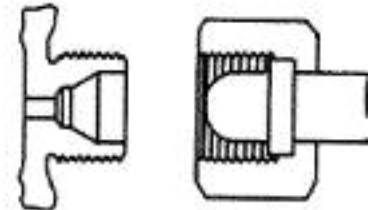

**CGA Connection No. 540**

.903-14NGO-RH-EXT

Oxygen

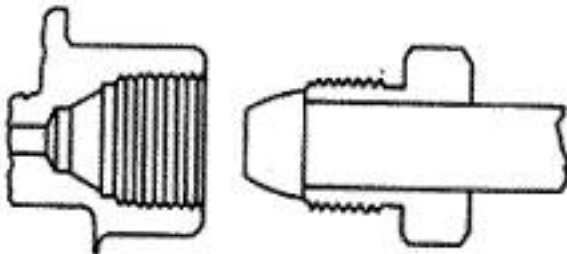

**CGA Connection No. 580**

.965-14NGO-RH-INT

Helium

Nitrogen

Xenon

## Medical Gas Cylinder Valves - Pin-Indexed Connections



Post Type Valve with Pin-Indexed Outlet

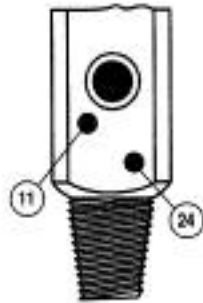

CGA Connection No. 973 Medical Cylinder Valve Connection (The CGA 860 non-indexed valve has been replaced by CGA 973 for various nonflammable, non-corrosive medical gas mixtures.)



CGA Connection No. 965 Medical Cylinder Valve Connection N<sub>2</sub>O & O<sub>2</sub> mix (N<sub>2</sub>O 47.5 to 52.5%)

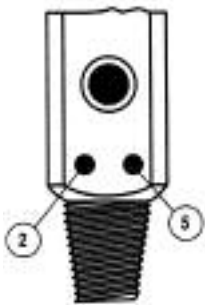

CGA Connection No. 870 Valve Yoke Connection Oxygen

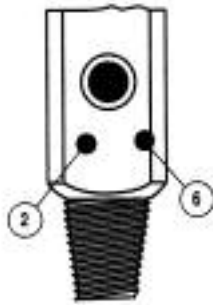

CGA Connection No. 880 Medical Cylinder Valve Connection Carbon Dioxide-Oxygen Mixtures (CO<sub>2</sub> ≤ 7.0%)

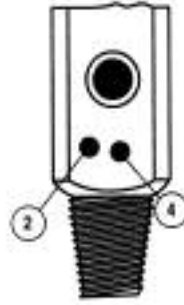

CGA Connection No. 890 Medical Cylinder Valve Connection Helium-Oxygen Mixtures (He ≤ 80.0%) Xenon-Oxygen Mixtures (Xe ≤ 80.0%) Nitrogen-Oxygen Mixtures (O<sub>2</sub> > 23.5%)

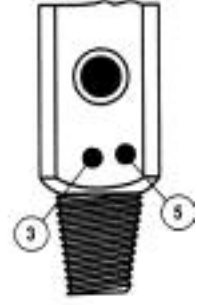

CGA Connection No. 910 Medical Cylinder Valve Connection Nitrous Oxide

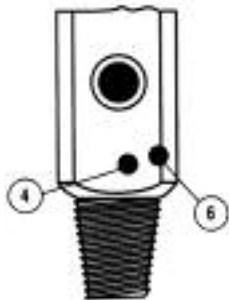

CGA Connection No. 930 Medical Cylinder Valve Connection Helium Helium-Oxygen Mixtures (He > 80.0%)

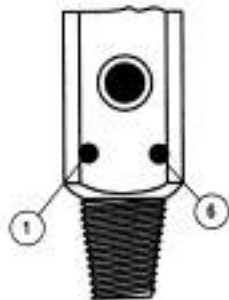

CGA Connection No. 940 Medical Cylinder Valve Connection Carbon Dioxide Carbon Dioxide-Oxygen Mixtures (CO<sub>2</sub> > 7.0%)

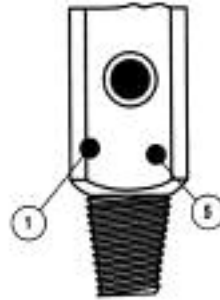

CGA Connection No. 950 Medical Cylinder Valve Connection Medical air

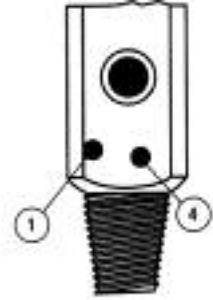

CGA Connection No. 960 Medical Cylinder Valve Connection Nitrogen

# Technical Information

## Wall Outlets - Adapter Identification

For Proper Outlet and Outlet Identification, use Chart Below.

W  
A  
L  
L  
  
O  
U  
T  
L  
E  
T  
S



Ohmeda Diamond



D.I.S.S.



Schrader



Chemetron (NCG)  
Rectangle Locking Pin



Chemetron (NCG)  
Round Locking Pin



Puritan-Bennett  
(Beacon Medical)



Oxequip  
O.E.S. (Twist)



Oxequip  
Med\* Star



Dynacon  
(Nitrogen)



Ohmeda Diamond



D.I.S.S. Hand Nut



D.I.S.S. Nut & Gland



Schrader



Chemetron (NCG)  
Rectangle Locking Pin



Chemetron (NCG)  
Round Locking Pin



Puritan-Bennett  
(Beacon Medical)



Oxequip  
O.E.S. (Twist)



Oxequip  
Med\* Star



Dynacon  
(Nitrogen)

A  
D  
A  
P  
T  
E  
R  
S



# Public Health Notification

## FDA and NIOSH Public Health Notification: Oxygen Regulator Fires Resulting from Incorrect Use of CGA 870 Seals

(You are encouraged to copy and distribute this information)

Issued: April 24, 2006



Dear Colleagues:

This is to alert you to the danger of fires at the interface of oxygen regulators and cylinder valves because of incorrect use of CGA 870 seals, and to point out an important precaution you can take to avoid such fires.

### Background

FDA has received 12 reports in which regulators used with oxygen cylinders have burned or exploded, in some cases injuring personnel. Some of the incidents occurred during emergency medical use or during routine equipment checks. FDA and NIOSH believe that improper use of gaskets/washers in these regulators was a major factor in both the ignition and severity of the fires, although there are likely other contributing factors.

Two types of washers, referred to as CGA 870 seals, are commonly used to create the seal at the cylinder valve / regulator interface: The type required by many regulator manufacturers is a metal-bound elastomeric **sealing washer** (Figure 2) that is designed for multiple use applications. The other common type, often supplied free-of-charge with refilled oxygen cylinders, is a plastic (usually Nylon®) **crush gasket** (Figure 1) suitable for single use applications.

The nylon crush gaskets require higher torque than the elastomeric sealing washers in order to seal the cylinder valve / regulator interface, and if they are used again, they require more torque with each successive use. The cylinder valve / regulator connection is designed to be hand-tightened. If the crush gaskets are re-used, the need for increased torque may require using a wrench or other hand tool, which can deform the crush gasket and damage the cylinder valve and regulator. This can result in leakage of oxygen past the cylinder valve seat and across the nylon crush gasket. According to a forensic analysis supported by FDA and NIOSH, "flow friction" caused by this leakage of compressed oxygen across the surface of the crush gasket may produce enough thermal energy to spontaneously ignite the nylon gasket material.

### Recommendations

**FDA and NIOSH recommend that plastic crush gaskets never be reused**, as they may require additional torque to obtain the necessary seal with each subsequent use. This can deform the gasket, increasing the likelihood that oxygen will leak around the seal and ignite.

The following general safety precautions should also be taken to avoid explosions, tank ruptures and fires from oxygen regulators.

- Always "crack" cylinder valves (open the valve just enough to allow gas to escape for a very short time) before attaching regulators in order to expel foreign matter from the outlet port of the valve.
- Always follow the regulator manufacturer's instructions for attaching the regulator to an oxygen cylinder.
- Always use the sealing gasket specified by the regulator manufacturer.
- Always inspect the regulator and CGA 870 seal before attaching it to the valve to insure that the regulator and seal are in good condition and the regulator is equipped with only one integral metal and rubber seal that is in good condition. Avoid plastic seals.
- Tighten the T-handle firmly by hand, but do not use wrenches or other hand tools that may over-torque the handle.
- Open the post valve slowly, while maintaining a grip on the valve wrench so that it can be closed quickly if gas escapes at the juncture of the regulator and valve.



Figure 1: Examples of crush gaskets available for CGA 870 type medical post valves.



Figure 2: Examples of some sealing washers available for CGA 870 Style medical post valves.

### Reporting to FDA

To report your experience regarding the devices in this Notification, please use MedWatch, the FDA's voluntary reporting program. You may submit reports to MedWatch by phone at 1-800-FDA-1088; by FAX at 1-800-FDA-0178; by mail to MedWatch, Food and Drug Administration, 5600 Fishers Lane, Rockville, MD 20857-9787; or online at <http://www.fda.gov/medwatch/report.htm>.

### Getting More Information

If you have questions about this notification, please contact the April Stubbs-Smith, Office of Surveillance and Biometrics (HFZ-510), 1350 Piccard Drive, Rockville, Maryland, 20850, by Fax at 301-594-2968, or by e-mail at [phann@cdrh.fda.gov](mailto:phann@cdrh.fda.gov). You may also leave a voicemail message at 301-594-0650 and we will return your call as soon as possible.

FDA medical device Public Health Notifications are available on the Internet at <http://www.fda.gov/cdrh/safety.html>. You can also be notified through email on the day the safety notification is released by subscribing to our list server. To subscribe, visit: <http://list.nih.gov/archives/dev-alert.html>.

Sincerely yours,

Daniel Schultz, MD  
Director  
Center for Devices and Radiological  
Health Food and Drug Administration

Nancy Stout, Ed. D  
Director, Division of Safety Research  
CDC, NIOSH

PRSR STANDARD  
U.S. POSTAGE  
PAID  
PERMIT NO. 579  
ST. PETERSBURG FL



11300 49th Street North • Clearwater, FL 33762-4807  
Toll Free: (800) 237-6418 • Phone: (727) 573-0088 • Fax: (727) 571-3922  
[www.mercurymed.com](http://www.mercurymed.com)