

Laryngoscopes

MRI Fiber-Optic Laryngoscope Kit & Replacement Battery Pack

Clinicians can feel confident using the Rusch MRI Conditional Fiber-Optic Laryngoscope to carry out emergency intubations within the MR environment. This product is lightweight and distinctly specialized with a hard anodized black aluminum handle and gold plated blades for easy identification. The Rusch MRI laryngoscope kit allows the clinician to treat the patient without the need to remove them from the MRI suite.

Features:

- Unique design — black handle and gold plated fiber-optic clip offers a set that is clearly distinguishable from blades and handles used in other departments.
- Independently certified to support MR conditions with a static magnetic field of 3-Tesla or less and highest spatial gradient field of 720-Gauss/cm or less.
- Rusch quality product at an affordable price
- High intensity xenon bulb provides ultra bright white light.
- Light weight handle and blades for ease of use.
- Powered by low magnetic battery for safety in the MRI suite.



Kit Includes:

1. Total of six MR conditional blades (Macintosh Blades 2, 3, 4 & Miller Blades 1, 2, 3)
2. One MR conditional (ultra-safe style) hard anodized aluminum medium size handle.
3. Two MR conditional special battery packs

- #12-005852300** Rusch MRI Conditional Fiber-Optic Laryngoscope Kit
- #12-005853300** Replacement Battery Pack

The Viewmax® allows visualization of the vocal cords in even the most difficult cases. Designed by an Anesthesiologist to function like a standard laryngoscope, Viewmax® does not require special training. The product's unique advantage lies in its ability to allow intubation whether you are faced with a Mallampati Grade I or IV airway. It has a patented lens system that refracts the image approximately 20° from horizontal, allowing visualization of even the most anterior larynx. The exclusive lens system also provides visual confirmation of endotracheal intubation by allowing a clear view of the vocal cords even as the tube passes through.

• Functions exactly like a laryngoscope
 • Extreme anterior view
 • For routine visualization of larynx
 • Affordable



#12-135001

SNAP LIGHT™ Laryngoscope System

Removable Fiber Optics

Rusch SnapLight™ fiber optic laryngoscope blades are designed with the clinician in mind. The large diameter fiber optic bundle can be removed to simplify cleaning - no crevices or hard to reach areas. Our unique snap-on fit mechanism eliminates screws that can be misplaced.

Specifications:

- Large diameter fiber optic light pipe
- Easy to remove fiber bundle
- Green system fitting to ISO 7376-3 specifications
- Lifetime warranty; free from manufacturing defects

Benefits:

- Bright, focused light
- Easy to clean
- No screws to keep track of
- Interchangeable with other Green systems

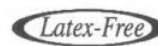
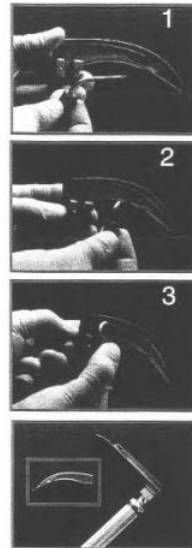

Fiber Optic Handle

Item No	Size	Box Qty	Battery Size
#12-004412200	Small/Penlight	1	2 x "AA"
#12-004411100	Med/Standard	1	2 x "C"
#12-004413300	Stubby Short	1	2 x "AA"

Replacement Lamp #12-0056300000

Macintosh Blade

Item No	Size	Box Qty	Replacement Bundle Part #
#12-002201100	1 Infant	1	#12-002501100
#12-002202200	2 Child	1	#12-002502200
#12-002203300	3 Med Adult	1	#12-002503300
#12-002204400	4 Large Adult	1	#12-002504400

Miller Blade

Item No	Size	Box Qty	Replacement Bundle Part #
#12-002200000	00 Small Premi	1	#12-002500000
#12-002215000	0 Premature	1	#12-002515000
#12-002216100	1 Infant	1	#12-002516100
#12-002217200	2 Child	1	#12-002517200
#12-002218300	3 Med Adult	1	#12-002518300
#12-002219400	4 Large Adult	1	#12-002519400

Laryngoscopes/Macintosh Flexible Tip Blades (Conventional Illumination)

Laryngoscopes with Conventional Illumination

SUN-FLEX™ (Flexible Tip)

- Satin finish
- Extra bright reflector lamp
- English channel to help visualize the epiglottis
- Surgical stainless steel construction
- Precise control to elevate the epiglottis
- Tip has non-pinching design

Manufactured to provide both conventional and fiber optic flexible laryngoscope blades. Another product to assist you with difficult intubations.

Blades made of surgical stainless steel.

English Profile



Replacement Lamps #53-5-0234-14

NEW! Parabolic Reflector Lamp
provides 40% more light.

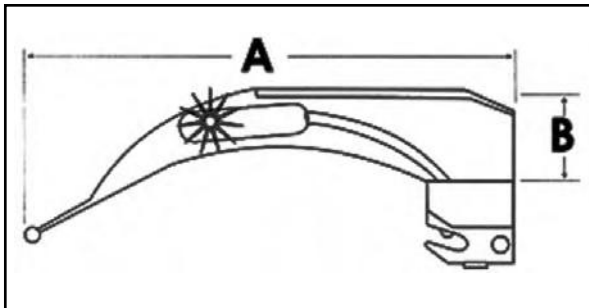

Macintosh Flexible Tip Blades/English Profile with Conventional Illumination

Part #	Size	Description	Dimensions	
			A	B
#53-5-5082-03	3	Medium Adult	132mm	25mm
#53-5-5082-04	4	Large Adult	155mm	26mm



Sun-Flex Macintosh Kit

#53-5-5082-42 Sun-Flex Macintosh Kit

KIT INCLUDES:

- Sun-Flex blades, sizes 3 and 4
- 1 medium chrome-plated handle (stainless steel available)
- 1 extra reflector lamp
- Foam carrying case

Laryngoscopes/Macintosh Flexible Tip Blades (Fiber Optic Illumination)

Laryngoscopes with Fiber Optic Illumination

SUN-FLEX™ Green Fiber Optic (Flexible Tip)

- Satin finish
- English channel to help visualize the epiglottis
- Fiber optic bundle can be replaced when service is required
- Stainless steel construction
- Precise control to elevate the epiglottis
- Tip has non-pinching design

Manufactured to provide both conventional and fiber optic flexible laryngoscope blades. Another product to assist you with difficult intubations.

Blades are made of surgical stainless steel.

English Profile

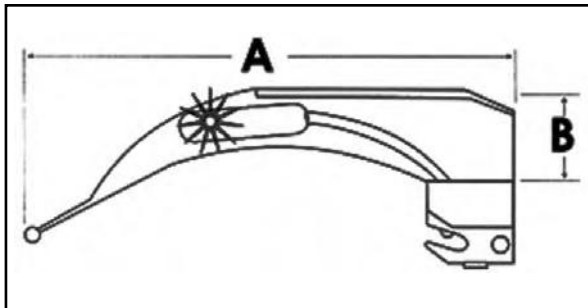

Macintosh Flexible Tip Blades/English Profile with Fiber Optic Illumination

Part #	Size	Description	Dimension	
			A	B
#53-5-5282-03	3	Medium Adult	132mm	23mm
#53-5-5282-04	4	Large Adult	155mm	26mm

Sun-Flex Macintosh Kit

#53-5-5282-42 Sun-Flex Macintosh Kit

KIT INCLUDES:

- Sun-Flex blades, sizes 3 and 4
- 1 medium chrome-plated handle (stainless steel available)
- 1 extra reflector lamp
- Foam carrying case

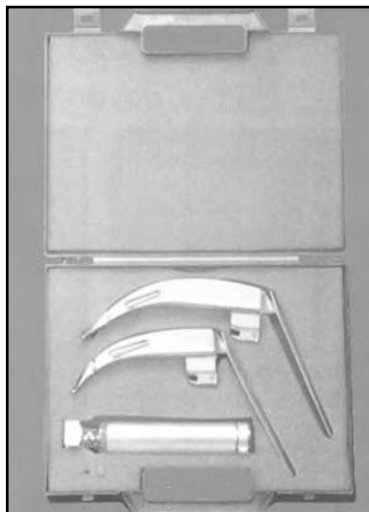

All above blades are made from 303/304 surgical stainless steel and are provided with 4mm, replaceable fiber optic bundles. GreenLine® blades and handles are fully compliant with ISO standard 7376-3 and interchange perfectly with companies conforming to the "Green System," (i.e., Anesthesia Associates, AMS, Heine, Proper, Rusch and Welch Allyn).

Laryngoscopes/Fiber Optic

UPSHER® Fiber Optic Laryngoscopy Systems

SHEDDING MORE LIGHT ON THE SUBJECT...

- Largest assortment of interchangeable blades with Upsher handles.
- High-powered argon lamp provides up to four times the illumination of many conventional lamps.
- No internal wiring to break, fray or corrode.
- Compatible with other standard blades that have hook-on fittings in accordance with ISO #7376-1 and ASTM #F965 standards.
- Water-resistant handles.
- Low maintenance.
- Can be used with light source and Power Handle for maximum luminescence in viewing a traumatized airway.



Maximum reliability and longevity in an instrument you'll want to use for years.

UPSHER Blades

Part #	Description	Size
#10-190-10	MacIntosh Blade	#1
#10-190-20	MacIntosh Blade	#2
#10-190-30	MacIntosh Blade	#3
#10-190-90	MacIntosh Blade	#3.5
#10-190-40	MacIntosh Blade	#4

Part #	Description	Size
#10-292-00	Miller Blade	#0
#10-292-10	Miller Blade	#1
#10-192-20	Miller Blade	#2
#10-192-30	Miller Blade	#3
#10-192-40	Miller Blade	#4

Specialty Blades

Part #	Description	Size
#10-196-10	ULX™ MacIntosh Blade	#1
#10-196-20	ULX™ MacIntosh Blade	#2
#10-196-30	ULX™ MacIntosh Blade	#3
#10-196-40	ULX™ MacIntosh Blade	#4
#10-197-20	IV MacIntosh Blade	#2
#10-197-30	IV MacIntosh Blade	#3
#10-197-40	IV MacIntosh Blade	#4



Area of Improved Vision with IV MacIntosh

Note: Fiber Optic Repolishing Service is Available at no charge. Light bundles are removable and can be repolished up to 3 times extending the life of the blade and restoring light intensity.

Laryngoscopes/2001 Fiberlight

A Fiber Optic Laryngoscope Blade That Fits On Your
Standard Handle,
is waterproof, and gives you more light!

**The 2001 Fiberlight allows you to mix
Standard and Fiber Optic blades
avoiding handle compatibility issues.**



Use your own standard handles with this blade. Save on the cost of a new one. The engineering in the 2001 FIBERLIGHT® Laryngoscope kept the bulb in the blade.

By positioning the light in the bottom of the blade, flickering, corrosion and the possibility of a loose bulb entering the oral airway has been eliminated.

Equally important, there is no longer a hot bulb in the oral cavity. Also, the bulb is easily accessible for checking or removal.



Light is located in the
bottom of the blade.



Standard laryngoscope handles with fittings manufactured to ASTM standards.

Laryngoscopes/2001 Fiberlight

Stainless Steel - Polished Finish

Part #	Description	Size	Light Position	Type Of Patient
#10-77607	F/O MacIntosh	Size 1		Infant
#10-77608	F/O MacIntosh	Size 2		Child
#10-77609	F/O MacIntosh	Size 3		Medium Adult
#10-77610	F/O MacIntosh	Size 4		Large Adult
#10-77700	F/O Miller	Size 0	Left	Premature
#10-77701	F/O Miller	Size 1	Left	Infant
#10-77707	F/O Miller	Size 2	Left	Child
#10-77702	F/O Miller	Size 2	Right	Child
#10-77708	F/O Miller	Size 3	Left	Medium Adult
#10-77703	F/O Miller	Size 3	Right	Medium Adult
#10-77709	F/O Miller	Size 4	Left	Large Adult
#10-77704	F/O Miller	Size 4	Right	Large Adult
#10-77800	F/O Phillips	Size 1		Child
#10-77801	F/O Phillips	Size 2		Adult

FEATURES:

- Removable light bundles can be repolished extending blade life - up to 3 times.
- Damaged light bundles can be replaced at a fraction of the cost of a new blade.
- Light bundle available on the right side for Miller #2, #3 and #4.
- Design allows you to mix standard and fiber optic blades.

The **2001 FIBERLIGHT®** Laryngoscope Blade is constructed of long-lasting Stainless Steel (polished finish).

This fiber optic laryngoscope blade was made especially for your existing standard handles.



Bundles can be easily replaced by simply unscrewing.



**Our light is in the blade,
Not in the handle!**

(Designed to fit Standard Handles)

#53-5-0237-93 Medium Handle (Waterproof)
#53-3-0237-91 Penlight Handle (Waterproof)



#10-77301 2001 Replacement Lamp
The light is located in the bottom of the blade.

Note: Light bundles are removable and can be repolished up to 3 times extending the life of the blade and restoring light intensity.

The Light bundle is now available on the right or left side of the Miller #2, #3 and #4 blades.

Laryngoscopes/Fiber Optic

PROPPER INTEGRATED (Heine Style) FIBER OPTIC LARYNGOSCOPES

The premier blade with the fiber optic bundle integrated in stainless steel.

Whiter and Brighter Light

- High intensity bulbs give off a brighter, whiter light.
- Yellowish tinge alerts you to insert fresh batteries.

Bulb is in the handle - not in the blade

- Bulb does not enter patient; blade stays cool.
- Eliminates electrical problems of ordinary laryngoscopes.

Integrated blade is easy to clean

- Fiber optic bundle is a permanent part of the blade, protected by stainless steel.
- No need to take the blade apart to clean it.

Components can be sterilized

- Blade and outer compartment of the handle can be sterilized with any approved EO gas sterilization cycle.

Detailed sterilization instructions are provided with each instrument.

Because the bulb is in the handle only one size bulb is needed to light any Propper fiber optic laryngoscope blade.

Item Number

Blades

#5261-199161	MacIntosh #1
#5261-199144	MacIntosh #2
#5261-199145	MacIntosh #3
#5261-199146	MacIntosh #4
#5261-199162	MacIntosh #5
#5261-199153	Propper #0 (Straight)
#5261-199147	Propper #1 (Straight)
#5261-199156	Miller #0
#5261-199157	Miller #1
#5261-199158	Miller #2
#5261-199159	Miller #3
#5261-199163	Wisconsin #1
#5261-199164	Wisconsin #2
#5261-199165	Wisconsin #3

Sets

#5261-199175	Small Set
#5261-199176	Large Set
#5261-199177	Complete Set

Handles

#5261-199150	2.5 - uses 2 "C" batteries
#5261-199152	2.5 - uses 2 "AA" batteries
#5261-199578	2.5 - uses 2 "AA" batteries

Bulbs

#5261-199407	2.5 - Halogen, high - intensity
--------------	---------------------------------

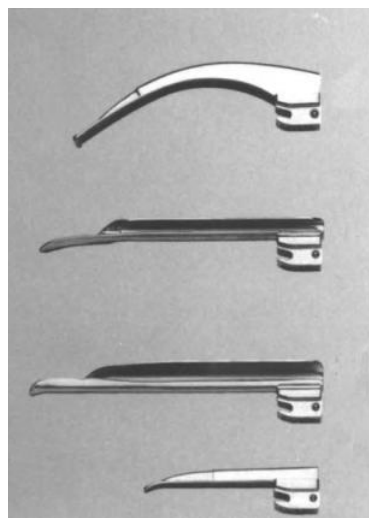

MacIntosh #3

Miller #2

Wisconsin #3

Propper #1

Sets

#5261-199175 Small Set : Contains one each of Propper #1, MacIntosh #3, and Miller #3 blades, plus a large handle and small handle in compact case (not shown).

#5261-199176 Large Set : Contains 5 MacIntosh blades, 5 Miller Blades, 2 Propper blades, and 2 handles in a rigid carrying case (not shown).

#5261-199177 Complete Set : Contains 5 MacIntosh blades, 5 Miller Blades, 3 Wisconsin blades, 2 Propper blades, and 3 handles in a rigid carrying case.



Laryngoscopes/Fiber Optic



FEATURES:

- Integral fiber bundle.
- 303/304 Surgical Stainless Steel.
- The lamp provides a very white, bright Light.
- No cracks or crevices to trap debris - helps to prevent cross contamination.
- Cleaning/Sterilization, no adverse effect in using ETO, steam autoclaving, or by soaking in Sporax, Cidex.
- Lamp is in the handle - providing a protected light source.
- Handles - four available: Medium, Penlight, Stubby and Large.
- Large Fiber Optic Bundles offer more light.
- Green Coded Fiber Optic Blades are compatible with Heine, AMS, Propper, Welch Allyn, Rüschi-Green Spec,[®] Anesthesia Associates - Greenline.

- Built with an integral extra large fiber optic bundle, providing more cool, white light.
- The design enables superior cleaning by elimination of cracks and crevices.
- Compatible with all "Green" Fiber Optic Systems.

MACINTOSH

#53-5-5272-01	Green German F/O	Size 1
#53-5-5272-02	Green German F/O	Size 2
#53-5-5272-03	Green German F/O	Size 3
#53-5-5272-04	Green German F/O	Size 4

MILLER

#53-5-5273-20	Green German F/O	Size 00
#53-5-5273-00	Green German F/O	Size 0
#53-5-5273-01	Green German F/O	Size 1
#53-5-5273-02	Green German F/O	Size 2
#53-5-5273-03	Green German F/O	Size 3
#53-5-5273-04	Green German F/O	Size 4

Laryngoscopes/Fiber Optic

FEATURES:

- Lightweight Stainless Steel Blades.
- No Electrical Contact in the Blade - More Reliable.
- New Fiber Optic Lamp - a Brighter, Cool, White Light.

PLEASE NOTE: Green Coded Fiber Optic Handles and Blades are compatible with the following companies "GREEN" System Manufacturers:

Welch Allyn, Rusch-Green Spec, Propper, Heine, AMS, Anesthesia Associates - Greenline



MACINTOSH - AMERICAN PROFILE

			Overall Length
#53-5-5231-00	Newborn	Size 0	80mm
#53-5-5231-01	Infant	Size 1	87mm
#53-5-5231-02	Child	Size 2	108mm
#53-5-5231-03	Medium Adult	Size 3	128mm
#53-5-5231-04	Large Adult	Size 4	159mm
#53-5-5231-35	Ext. Medium Adult	Size 3.5	144mm

MACINTOSH EXTENDED FLANGE - ENGLISH PROFILE

			Overall Length
#53-5-5232-01	Infant	Size 1	92mm
#53-5-5232-02	Child	Size 2	100mm
#53-5-5232-03	Medium Adult	Size 3	130mm
#53-5-5232-04	Adult	Size 4	155mm
#53-5-5232-05	Ext. Lg. Adult	Size 5	175mm
#53-5-5243-03	Left Hand	Size 3	130mm



MILLER - AMERICAN PROFILE

			Overall Length	
#53-5-5230-02	Child	Size 2	155mm	right illumination
#53-5-5230-03	Med. Adult	Size 3	195mm	right illumination
#53-5-5233-20	Premature	Size 00	67mm	left illumination
#53-5-5233-00	Newborn	Size 0	77mm	left illumination
#53-5-5233-01	Infant	Size 1	102mm	left illumination
#53-5-5233-02	Child	Size 2	153mm	left illumination
#53-5-5233-03	Medium Adult	Size 3	195mm	left illumination
#53-5-5233-04	Large Adult	Size 4	205mm	left illumination

GREEN SYSTEMS FIBER OPTIC HANDLES

#53-5-0236-09	Medium (Standard) Handle	F/O
#53-5-0236-10	Penlight Handle	F/O
#53-5-0236-11	Stubby Handle	F/O
#53-5-0236-15	Large Handle	F/O
#53-5-0240-52	Lamp Xenon	3.5mm



Laryngoscopes/Fiber Optic

Welch Allyn

Miller Halogen Fiber Optic

Item Number	Size	Inside Vertical Measure	Length Inside Base To Tip
#6783-68060	#0	8mm	53mm
#6783-68061	#1	8mm	79mm
#6783-68062	#2	10mm	132mm
#6783-68063	#3	11mm	172mm
#6783-68064	#4	13mm	182mm



Macintosh Halogen Fiber Optic

Item Number	Size	Length Overall	Length Inside Base To Tip
#6783-69061	#1	89mm	63mm
#6783-69062	#2	108mm	82mm
#6783-69063	#3	126mm	101mm
#6783-69064	#4	160mm	135mm



Portable Fiber Optic Sets

- #6783-65101 Portable set includes laryngoscope Blades (MacIntosh #3, Miller #0, Miller #2), #6783-60813 "C" cell handle and case #6783-05620
- #6783-65102 Portable set includes laryngoscope Blades (MacIntosh #3, Miller #0, Miller #2), #6783-60814 "AA" cell handle and case #6783-05620
- #6783-65103 Portable set includes laryngoscope Blades (MacIntosh #3, MacIntosh #4), #6783-60813 "C" cell handle and case #6783-05620
- #6783-65104 Portable set includes laryngoscope Blades (MacIntosh #3, MacIntosh #4), #6783-60814 "AA" cell handle and case #6783-05620



Fiber Optic Handles

Lightweight

Redesigned to reduce total weight, Welch Allyn's new lightweight handles are up to 40% lighter than the previous design. This, coupled with a 50% reduction in blade weight, adds up to a responsive and maneuverable system. Fiber optic handles are available in both "C" and "AA" sizes.

- #6783-60813 "C" size fiber optic battery handle
- #6783-60814 "AA" size fiber optic battery handle
- #6783-06000 Halogen replacement lamp

Stubby

- #6783-60815 Fiber optic stubby handle
- #6783-06000 Halogen replacement lamp



Laryngoscopes/Fiber Optic

RUSCH LARYNGOSCOPE SYSTEMS

Fiber Optic Laryngoscope Systems

FOCS Fiber Optic Blades

FOCS BLADE/MACINTOSH

(Fits All Standard¹ Handles)

Item Number	Size	Lamp
#12-005640	#1 Infant	#12-005630
#12-005641	#2 Child	#12-005630
#12-005642	#3 Med. Adult	#12-005630
#12-005643	#4 Lg. Adult	#12-005630



FOCS BLADE/MILLER

(Fits All Standard¹ Handles)

Item Number	Size	Lamp
#12-005650	#0 Premature	#12-005630
#12-005651	#1 Infant	#12-005630
#12-005652	#2 Child	#12-005630
#12-005653	#3 Med. Adult	#12-005630
#12-005654	#4 Lg. Adult	#12-005630



LYNCS Fiber Optic Blades and Handles

LYNCS BLADE/MACINTOSH

(Fits All Standard¹ Handles²)

Item Number	Size	Lamp
#12-008301	#1 Infant	Lamp in
#12-008302	#2 Child	LYNCS
#12-008303	#3 Med. Adult	Handles
#12-008304	#4 Lg. Adult	

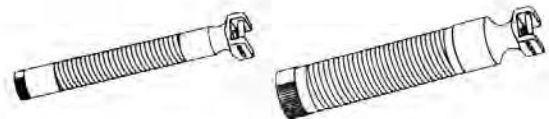

LYNCS BLADE/MILLER

(Fits All Standard¹ Handles²)

Item Number	Size	Lamp
#12-008315	#0 Premature	Lamp in
#12-008316	#1 Infant	LYNCS
#12-008317	#2 Child	Handles
#12-008318	#3 Med. Adult	
#12-008319	#4 Lg. Adult	

LYNCS Fiber Optic Handle

(Fits All Rusch Lyncs Fiber Optic² blades and standard blades)

Item Number	Size	Lamp
#12-008320	Small Penlight	#12-008322
#12-008321	Med./Standard	#12-008322

LYNCS HALOGEN LAMPS

#12-008322-000 6/BX

FOCS HALOGEN LAMPS

#12-005630 6/BX



Caution: Sudden cooling following heat sterilization may damage Fiber Optics. (Such as immediate immersion in cool water).

Laryngoscopes/Fiber Optic



Rusch Fiber Optic Laryngoscope System

The Green spec system is designed to interchange with the green coded fiber optic systems.

MacIntosh
Fiber Optic Blade
Non-Sterile

- Stainless steel
- Lamp is in fiber optic handle
- Green color coding

Light side	Item number	Size	Box
Left	#12-004431100	1 Infant	1
Left	#12-004432200	2 Child	1
Left	#12-004433300	3 Medium Adult	1
Left	#12-004434400	4 Large Adult	1



Miller
Fiber Optic Blade
Non-Sterile

- Stainless steel
- Lamp is in fiber optic handle
- Green color coding

Light side	Item number	Size	Box
Left	#12-004449000	00 Small Prem	1
Left	#12-004450050	0 Premature	1
Left	#12-004451100	1 Infant	1
Left	#12-004452200	2 Child	1
Left	#12-004453300	3 Medium Adult	1
Left	#12-004454400	4 Large Adult	1



Oxiport Miller
Fiber Optic Blade
Non-Sterile

- Stainless steel
- Lamp is in fiber optic handle
- Green color coding

Light side	Item number	Size	Box
Left	#12-004457700	00 Small Prem.	1
Left	#12-004458800	0 Prem.	1

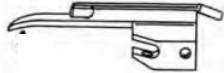

Green spec
Fiber Optic Handle
Non-Sterile

- Satin finish chrome plated brass
- Lamp supplied in handle
- Green color coding

Item number	Battery size	Size	Box
#12-004411100	2 x "CC"	Med/Standard	1
#12-004412200	2 X "AA"	Small/Penlight	1
#12-004413300	2 X "AA"	Stubby/Short	1

#12-004411100



#12-004412200



#12-004413300



Bulb for Green Spec System
12-008322000
Non-Sterile lamp



NOTE:

Green coded systems worldwide are in general designed to interchange. However, differences in design give some variation in the strength of the locking action.

Interchanges well with other systems using locking balls on both sides of the blades, e.g. Heine, Propper.

Does not lock as firmly with single ball designs, e.g. Welch Allyn.

Laryngoscope Blades/Standard

Miller



The most popular of the straight blade types. The side of the flange is reduced to minimize trauma and the curve at the beak or tip is extended to improve lifting of the epiglottis. These improvements facilitate greater exposure of the larynx in difficult-to-intubate patients.

MacIntosh



The *MacIntosh* is the predominant choice of the curved blade types. During laryngoscopy, the tip or "beak" of the blade is compressed into the angle formed by the base of the tongue and the epiglottis (vallecula), indirectly raising the epiglottis.

The *MacIntosh Extended Flange* spatula of the blade has a smooth and gentle curve extending from the lock to the tip. In cross section, the construction resembles that of a Z flange, facilitating greater access during intubation.



Wisconsin/Wis Hipple



The *Wisconsin Laryngoscope Blade* offers a straight spatula and a flange that expands slightly toward the distal portion of the blade. This feature increases the visual field and reduces the possibility of trauma during intubation.

Miller - American Profile

Part #	Description	Size	Light Position	Overall Length
#53-5-5062-20	Premature	Size 00	Left	65mm
#53-5-5062-00	Neonate	Size 0	Left	75mm
#53-5-5062-01	Infant	Size 1	Left	102mm
#53-5-5062-02	Child	Size 2	Right	155mm
#53-5-5062-03	Med Adult	Size 3	Right	195mm
#53-5-5062-04	Lg Adult	Size 4	Right	205mm

MacIntosh - American Profile

Part #	Description	Size	Light Position	Overall Length
#53-5-5052-00	Premature	Size 0	Left	80mm
#53-5-5052-01	Infant	Size 1	Left	87mm
#53-5-5052-02	Child	Size 2	Left	108mm
#53-5-5052-03	Med Adult	Size 3	Left	128mm
#53-5-5052-35	Adult	Size 3.5	Left	144mm
#53-5-5052-04	Adult	Size 4	Left	159mm

MacIntosh-Extended Flange-English Profile

Part #	Description	Size	Light Position	Overall Length
#53-5-5051-00	Neonate	Size 0	Left	80mm
#53-5-5051-01	Infant	Size 1	Left	92mm
#53-5-5051-02	Child	Size 2	Left	100mm
#53-5-5051-03	Med Adult	Size 3	Left	130mm
#53-5-5051-04	Adult	Size 4	Left	155mm
#53-5-5051-05	X-Large Adult	Size 5	Left	175mm
#53-5-5053-03	Med Adult	Size 3	Right	130mm

Wisconsin/Wis-Hipple

Part #	Description	Size	Light Position	Overall Length
#53-5-5057-00	Premature	Size 0	Left	76mm
#53-5-5057-01	Infant	Size 1	Left	102mm
#53-5-5057-15	Infant	Size 1.5	Left	115mm
#53-5-5057-02	Child	Size 2	Left	135mm
#53-5-5057-03	Med Adult	Size 3	Left	162mm
#53-5-5057-04	Lg Adult	Size 4	Left	199mm

Laryngoscope Blades/Standard

Oxiport Miller



The *Oxiport* is a modification of the Miller or MacIntosh Blade that allows an individual to perform a laryngoscopy and intubation with less risk of hypoxia. A tube is built into these blades that permits delivery of O₂ or other gas mixtures during intubation.

Part #	Description	Size
#53-5-3078-00	Premature	Size 0
#53-5-3078-01	Infant	Size 1

Phillips



The *Phillips Laryngoscope® Blade* integrates the straight Jackson blade design with the curved distal tip Miller design, providing greater visibility and an almost direct line approach to the trachea during difficult intubations. Unique lamp mounting provides deep illumination downward and inward, while the low profile flange reduces the risk of oral damage.

Part #	Description	Size	Overall Length
#53-5-3073-01	Pediatric	Size 1	113mm
#53-5-3073-02	Adult	Size 2	166mm

Robert Shaw

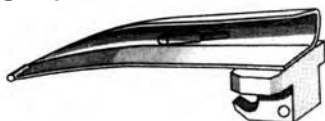

This blade for infants and children is gently curved over the distal third and is designed to lift the epiglottis indirectly in the manner of the Macintosh blade. The blade section permits binocular vision thus allowing better judgement of depth and consequently less risk of trauma.

Part #	Description	Size	Overall Length
#53-5-5077-00	Neonatal	Size 0	94mm
#53-5-5077-01	Infant	Size 1	112mm

Huffman Prism



Clipped to the vertical wall of an Adult size 2, 3 or 4 MacIntosh Blade, this device is used when the view of the vocal cord is impaired during nasal intubation and for post-operating examination of the larynx. It consists of an optically polished prism which provides a refraction of 30°. To prevent condensation, warm the prism before use by immersing it, (attached to the laryngoscope) in water at about 48°C (120°F).

Part #	Description	Size
#53-5-0241-02	For MacIntosh	#2
#53-5-0241-03	For MacIntosh	#3.5
#53-5-0241-04	For MacIntosh	#4

Laryngoscope Blades/Standard

E/C - E-MAC™ English Channel E-MacIntosh w/tube Guide

A modification of the “English” style MacIntosh laryngoscope blade. A channel in the blade provides a means through which an endotracheal tube may be inserted after visualizing the cords. A new parabolic reflector lamp provides four times more light.



Part #	Description	Size	MM
#53-5-5046-02	Eng. Channel E-Mac	Child Size 2	100mm
#53-5-5046-03	Eng. Channel E-Mac	Medium Adult Size 3	130mm
#53-5-5046-04	Eng. Channel E-Mac	Large Adult Size 4	155mm
#53-5-5046-35	Eng. Channel E-Mac	Adult Size 3-1/2	144mm

Bizzarri-Guiffrida*

(Flangeless MacIntosh)



A modification of the Macintosh Laryngoscope Blade with the flange eliminated to minimize the danger of damage to teeth, facilitates laryngoscopy of patients with limited mouth opening because of disease, injury, deformity, etc., and permits maximum anterior rotation of the distal end of the blade. Minimum discomfort when used on a conscious patient. Excellent for laryngoscopy of patients with protruding teeth, receding jaw, “bull neck” or larynx located in an extreme anterior anatomic position.

Part #	Description	Size	mm
#53-5-3072-03	Med Adult	Size 3	130mm
#53-5-3072-04	Large Adult	Size 4	158mm

Seward*



Originally produced as an infant blade for use in asphyxia neonatorum, this pattern is now available in two sizes extending its usefulness to older children.

Part #	Size	mm
#53-5-5079-01	Size 1	105mm
#53-5-5079-02	Size 2	130mm

Laryngoscope Blades/Standard

RUSCH STANDARD CONVENTIONAL LARYNGOSCOPES

Standard Conventional Laryngoscope Systems

STANDARD BLADE/MACINTOSH

(Fits All Standard Handles or LYNCS Fiber Optic Handle)

Item Number	Size	Lamp
#12-008601	#1 Infant	#12-008623
#12-008602	#2 Child	#12-008623
#12-008603	#3 Med. Adult	#12-008622
#12-008604	#4 Lg. Adult	#12-008622

#12-008601



#12-008600

STANDARD BLADE/MILLER

(Fits All Standard Handles or LYNCS Fiber Optic Handle)

Item Number	Size	Lamp
#12-008600	#00 Sm. Premature	#12-008623
#12-008615	#0 Premature	#12-008623
#12-008616	#1 Infant	#12-008623
#12-008617	#2 Child	#12-008623
#12-008618	#3 Med. Adult	#12-008623
#12-008619	#4 Lg. Adult	#12-008622



#12-008611

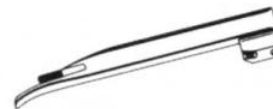

STANDARD BLADE/WISCONSIN

(Fits All Standard Handles or LYNCS Fiber Optic Handle)

Item Number	Size	Lamp
#12-008611	#1 Infant	#12-008623
#12-008612	#2 Child	#12-008622
#12-008613	#3 Med. Adult	#12-008622
#12-008614	#4 Lg. Adult	#12-008622

STANDARD CHROME HANDLE

(Fits Standard Blades, 2001 or LYNCS Fiber Optic Blades)

#12-008620	Small/Penlight
#12-008621	Med./Standard

#12-008620

#12-008621



STANDARD STAINLESS STEEL HANDLE

(Fits Standard Blades or LYNCS Fiber Optic Blades)

#12-142500	Med./Standard
#12-142600	Small/Penlight



#12-142600

#12-142500

Laryngoscope Blades/Disposable

Standard fitting Lite Blade™ Disposable Laryngoscope Blades

The standard laryngoscope blade that fits on a standard/conventional handle. Tested for tensile strength.

Lite Blade™	• Rigid plastic	• Light on the left	#12-004802-200	Size 2, Child, Qty/20 Box
Macintosh	• Disposable	• Light on the left	#12-004803-300	Size 3, Med Adult, Qty/20 Box
	• Single-use	• Light on the left	#12-004804-400	Size 4, Large Adult, Qty/20 Box

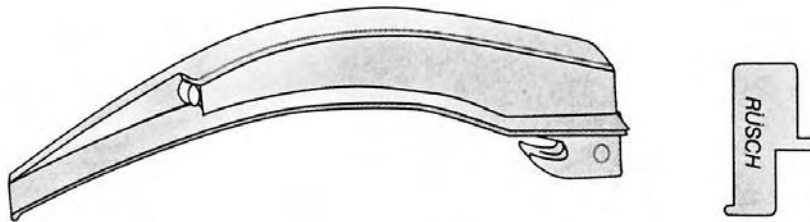

Lite Blade™	• Rigid plastic	• Light on the left	#12-004850-050	Size, 0 Premature, Qty/20 Box
Miller	• Disposable	• Light on the left	#12-004851-100	Size, 1 Infant, Qty/20 Box
	• Single-use	• Light on the left	#12-004852-200	Size, 2 Child, Qty/20 Box
		• Light on the left	#12-004853-300	Size, 3 Medium Adult, Qty/20 Box

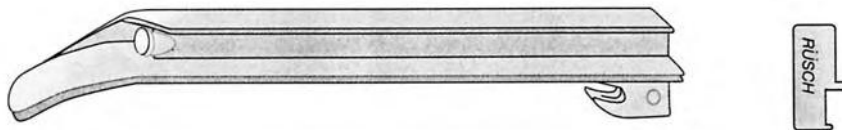

Lite Blade™ is a trademark of Rusch, Inc.

Laryngoscope/Fiber Optic/Disposable Blades

Laryngoscopes with Fiber Optic Illumination



GREENLINE®/D™

The GreenLine/D disposable laryngoscope blades solve contamination problems and eliminate the cost and time spent cleaning laryngoscope blades and returning them for use.

- Made of surgical stainless steel
- Suitable for everyday hospital use
- Answers the professional's request for a non-plastic disposable
- Perfect solution to cleaning problems confronting EMS field
- Polished acrylic stem produces exceptional illumination
- Used with a reusable "Green" system fiber optic handle. Compatible with: AMS, Anesthesia Associates, Heine, Propper, Rusch and Welch Allyn
- Sterile pack 20/box

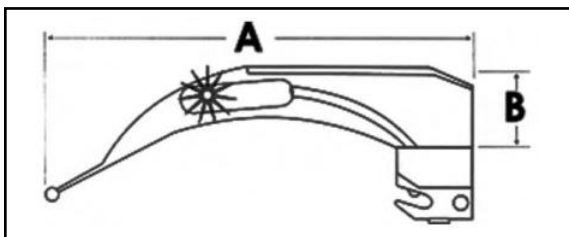

Disposable, Stainless Steel, Sterile, Fiber Optic Blades



Part #	Size	Description	Dimensions		Pkg.
			A	B	
#53-5-5333-00	0	Neonate	77mm	10mm	20/Bx
#53-5-5333-01	1	Infant	102mm	10mm	20/Bx
#53-5-5333-02	2	Child	153mm	12mm	20/Bx
#53-5-5333-03	3	Medium Adult	195mm	16mm	20/Bx
#53-5-5333-04	4	Large Adult	205mm	20mm	20/Bx

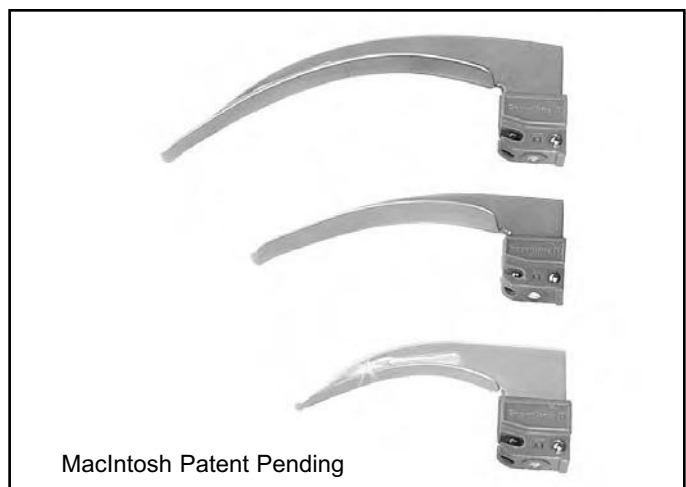

Part #	Size	Description	Dimensions		Pkg.
			A	B	
#53-5-5332-01	1	Infant	92mm	22mm	20/Bx
#53-5-5332-02	2	Child	100mm	21mm	20/Bx
#53-5-5332-03	3	Medium Adult	130mm	22mm	20/Bx
#53-5-5332-04	4	Large Adult	155mm	25mm	20/Bx

Laryngoscope Blades/Accessories



CONVENTION LARYNGOSCOPE HOWLAND LOCK

#53-5-0236-00

Natural lifting action simplifies laryngeal exposure, making intubation possible even in the most difficult cases. Built in leverage prevents prying and reduces the possible loss of broken teeth. Adapts to all types of hook-on laryngoscope handles and blades can often make an otherwise certain tracheostomy unnecessary.

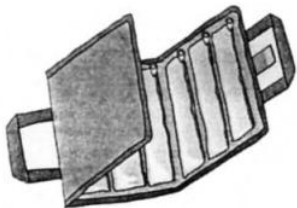

CARRYING CASE

Non-sterile

#12-008650-500



HUFFMAN STYLE PRISM

Clipped to the vertical wall of a MacIntosh Blade, this device is used when the view of the vocal cords is impaired during nasal intubation and for post-operating examination of the larynx. It consists of an optically polished prism which provides increased refraction.

To prevent condensation, warm the prism before use by immersing it (attached to the laryngoscope) in water at about 48° C (120° F).

#19-003492	Fits MacIntosh #2
#19-003493	Fits MacIntosh #3
#19-003494	Fits MacIntosh #4
#19-003495	Prism set includes 1 each of above.

Conventional Laryngoscope Sets (American & English Profiles)

Conventional Laryngoscope Sets American & English Profiles



MacIntosh American Profile

Miller American Profile

MacIntosh/Miller English
Profile Combination Set

Features:

- Blades made of 303/304 surgical stainless steel
- High impact plastic case - for ease of transport
- MacIntosh - Miller sets are available
- Complete sets of most popular laryngoscope blades
- Medium handle and two extra lamps included
- Kits supplied with chrome plated handle (stainless steel also available)
- Most economical
- 5-year warranty (excludes lamp)
- Convenient

MacIntosh American Profile Set

#53-5-5052-44 Set includes: Medium Handle, 2 extra lamps and MacIntosh Blades, Size: 1, 2, 3, 4

MacIntosh English Profile Set

#53-5-5051-44 Set includes: Medium Handle, 2 extra lamps and MacIntosh Blades, Size: 1, 2, 3, 4

Miller American Profile Set

#53-5-5062-45 Set includes: Medium Handle, 2 extra lamps and Miller Blades, Size: 0, 1, 2, 3, 4

Miller English Profile Set

#53-5-5061-45 Set includes: Medium Handle, 2 extra lamps and Miller Blades, Size: 0, 1, 2, 3, 4

MacIntosh/Miller Combination Set - American Profile

#53-5-5062-47 Set includes: Medium Handle, 2 extra lamps and MacIntosh Blades, Size: 2, 3, 4 and Miller Blades, Size: 0, 1, 2, 3

MacIntosh/Miller Combination Set - English Profile

#53-5-5061-47 Set includes: Medium Handle, 2 extra lamps and MacIntosh Blades, Size: 2, 3, 4 and Miller Blades, Size: 0, 1, 2, 3

Laryngoscopes/Handles

LARYNGOSCOPE STANDARD BLADE HANDLES

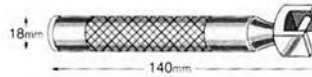

#53-5-0237-91 Penlight Handle (Waterproof) accepts two "AA" batteries, 140mm

#53-5-0237-01 Standard Penlight Handle accepts two "AA" batteries, 140mm

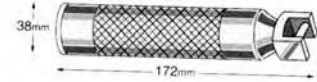

#53-5-0237-05 Large Handle accepts two "D" batteries, 172mm

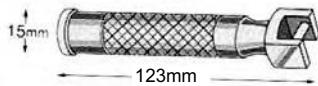

#53-5-0237-08 Standard Stubby Penlight Handle with 2 "N" batteries, 123mm

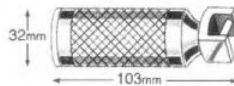

#53-5-0237-92 Stubby Handle (Waterproof) - accepts two "AA" batteries, 103mm

#53-5-0237-02 Standard Stubby Handle - accepts two "AA" batteries, 103mm

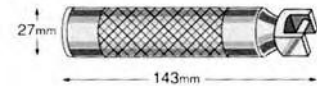

#53-5-0237-93 Medium Handle (Waterproof) accepts two "C" batteries, 143mm

#53-5-0237-03 Standard Medium Handle accepts two "C" batteries, 143mm

ADJUSTABLE PATIL-SYRACUSE HANDLE

#19-00-340 This handle allows the blade to be positioned and locked in four different positions: 180°, 135°, 90°, standard or 45° (Howland Lock Angle). In the 180° position, the blade can be introduced parallel to the handle when extension of the neck is contraindicated because of cervical spine fractures or instability. Visualization of the larynx is also facilitated in obese patients or those in halo traction. In the 45° position, all advantages of the Howland Lock are achieved. The handle accepts two "AA" batteries and fits all hook-on type laryngoscope blades. The overall length and weight of the handle is approximately the same as that of a conventional handle.

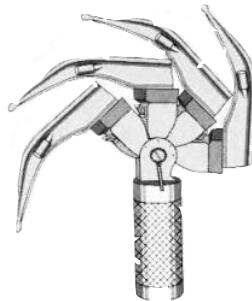

**ABLE TO
LOCK IN 4
DIFFERENT
POSITIONS!**

HOWLAND LOCK



#53-5-0236-00 Standard Howland Lock

#53-5-0236-16 Green System Howland Lock

Natural lifting action simplifies laryngeal exposure, making intubation possible even in the most difficult cases. Built-in leverage prevents prying and reduces the possible loss of broken teeth. Adapts to all types of hook-on laryngoscope handles and blades. Can often make an otherwise certain tracheostomy unnecessary.

Laryngoscopes/Fiber Optic Handles

UPSHER Fiber Optic Handles

The UPSHER Universal Handle® is the ultimate in versatility. The uniquely designed handle is compatible with the Upsher fiber optic blades and most standard bulb type blades.



Get A Grip



#10-19250
Stubby
Universal
Handle®

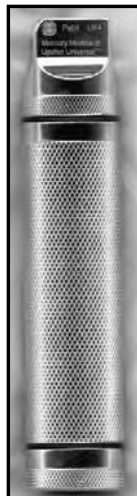

#10-18000
Standard
Universal
Handle®

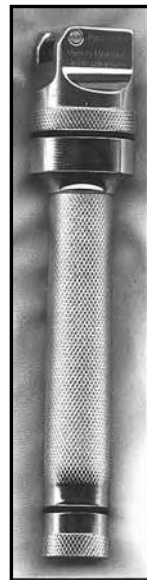

#10-19150
Penlight
Universal
Handle®

- Fits Upsher Fiber Optic Blades
- Fits Most Standard Bulb Blades

Upsher Universal Handles

Part #	Description	Battery Size
#10-180-00	F/O Standard Handle, lightweight	2 "C" batteries
#10-191-50	F/O Penlight Handle	2 "AA" batteries
#10-192-50	F/O Stubby Handle	2 "AA" batteries
#10-200-30	F/O Micro Handle (<i>not shown</i>)	1 #72-DC123AB (3 volt lithium)

Lamps

Part #	Description
#10-190-80	Replacement Lamp (black insulator)
#10-200-85	Replacement Lamp (blue insulator)